

TOSHIBA

Toshiba 6-Slot Battery Charger

B-EP800-CHG6-QM-R

Owner's Manual

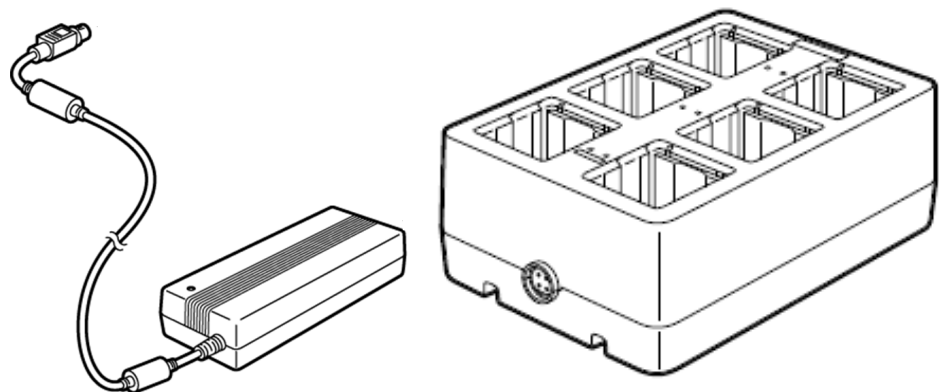

CE compliance:

This product is labelled with the CE mark in accordance with the provisions of the applicable European Directives for this product and the electric accessories.

CE marking is the responsibility of Toshiba Tec Germany Imaging Systems GmbH,
Carl-Schurz-Str. 7, 41460 Neuss, Germany, phone +49-(0)-2131-1245-0.

For a copy of the related CE Declaration of Conformity, please contact your dealer, Toshiba Tec Germany Imaging Systems GmbH or Toshiba Tec Corporation.

UKCA compliance:

This product is labelled with the UKCA mark in accordance with the provisions of the applicable UK legislations for this product and the electric accessories.

UKCA marking is the responsibility of Toshiba Tec U.K. Imaging Systems Ltd,
Abbey Cloisters, Abbey Green, Chertsey, Surrey, KT16 8RB, phone +44-(0)-843 2244944.

For a copy of the related UKCA Declaration of Conformity, please contact your dealer, Toshiba Tec U.K. Imaging Systems Ltd or Toshiba Tec Corporation.

FCC Notice:

1. This equipment has been tested and found to comply with the limits for a Class B digital device, pursuant to Part 15 of the FCC rules. These limits are designed to provide reasonable protection against harmful interference in a residential installation. This equipment generates, uses, and can radiate radio frequency energy and, if not installed and used in accordance with the instructions, may cause harmful interference to radio communications. However, there is no guarantee that interference will not occur in a particular installation. If this equipment does cause harmful interference to radio or television reception, which can be determined by turning the equipment off and on, the user is encouraged to try to correct the interference by one or more of the following measures:

- Reorient or relocate the receiving antenna.
- Increase the separation between the equipment and receiver.
- Connect the equipment into an outlet on a circuit different from that to which the receiver is connected.
- Consult the dealer or an experienced radio/TV technician for help.

2. Changes or modification not expressly approved by manufacturer for compliance could void the user's authority to operate the equipment.

This Class B digital apparatus meets all requirements of the Canadian Interference-Causing Equipment Regulations.

(for CANADA only)



This product is marked according to the requirement on Waste electrical and electronic equipment - WEEE.

The use of the symbol indicates that product may not be disposed as unsorted municipal waste and has to be collected separately. By ensuring this product is disposed of correctly, you will help prevent potential negative consequences for the environment and human health, which could otherwise be caused by inappropriate waste handling of this product.

For more detailed information about the take-back and recycling of this product please contact your supplier where you purchased the product.

CALIFORNIA PROPOSITION 65 WARNING**⚠ WARNING:**

This product can expose you to chemicals including DINP, which is/are known to the State of California to cause cancer, and chemicals including Phthalate[s], which is/are known to the State of California to cause birth defects or other reproductive harm.

For more information go to:

www.P65Warnings.ca.gov

Following information is only for India:

The use of the symbol indicates that this product may not be treated as household waste. By ensuring this product is disposed of correctly, you will help prevent potential negative consequences for the environment and human health, which could otherwise be caused by inappropriate waste handling of this product.

For more detailed information about the take-back and recycling of this product, please contact your supplier where you purchased the product.

This product including components, consumables, parts and spares complies with the "India E-Waste Rules" and prohibits use of lead, mercury, hexavalent chromium, polybrominated biphenyls or polybrominated diphenyl ethers in concentrations exceeding 0.1% by weight and 0.01% by weight for cadmium, except for the exemption set in the Rule.

This product is designed for commercial usage and is not consumer product.

**EAC**

Following information is only for Turkey:

AEEE Yönetmeliğine Uygundur



WARNING

This indicates that there is the risk of **death** or **serious injury** if the machines are handled improperly or contrary to this indication.

- Do not expose the unit to rain or moisture, as this may cause fire or electric shock.
- Do not use a spray cleaner containing flammable gas for cleaning this product, as this may cause a fire.
- Do not use voltages other than the AC voltage specified on the rating plate, as this may cause fire or electric shock.
- Do not plug in or unplug the power cord with wet hands as this may cause electric shock.
- Do not place metal objects or water-filled containers such as flower vases, flower pots or mugs, etc. on top of the machine. If metal objects or spilled liquid enter the machine, this may cause fire or electric shock. (4)
- Do not scratch, damage or modify the power cords. Also, do not place heavy objects on, pull on, or excessively bend the power cords, as this may cause fire or electrical shock.
- Do not remove covers, repair or modify the machine by yourself. Contact your authorised Toshiba Tec Corporation representative for assistance. You may be injured by high voltage, very hot parts or sharp edges inside the machine.
- If the machine is dropped or their cabinet damaged, first turn off the power switch and disconnect the power cord plug from the outlet, and then contact your authorised Toshiba Tec Corporation representative for assistance. Continued use of the machine in that condition may cause fire or electric shock.
- Continued use of the machine in an abnormal condition such as when the machine is producing smoke or strange smells may cause fire or electric shock. In these cases, immediately turn off the power switches and disconnect the power cord plug from the outlet. Then, contact your authorised Toshiba Tec Corporation representative for assistance.
- If foreign objects (metal fragments, water, liquids) enter the machine, turn off the power switch and disconnect the power cord plug from the outlet, and then contact your authorised Toshiba Tec Corporation representative for assistance. Continued use of the machine in that condition may cause fire or electric shock.
- When unplugging the power cords, be sure to hold and pull on the plug. Pulling on the cord may cut or expose the internal wires and cause fire or electric shock.
- Ensure that the equipment is properly grounded. Extension cables should also be grounded. Fire or electric shock could occur on improperly grounded equipment.



CAUTION

This indicates that there is the risk of personal **injury** or **damage** to objects if the machines are improperly handled contrary to this indication.

Precautions

The following precautions will help to ensure that this machine will continue to function correctly.

- Try to avoid locations that have the following adverse conditions:
 - * Temperatures out of the specification
 - * Direct sunlight
 - * High humidity
 - * Shared power source
 - * Excessive vibration
 - * Dust/Gas
- The cover should be cleaned by wiping with a dry cloth or a cloth slightly dampened with a mild detergent solution. **NEVER USE THINNER OR ANY OTHER VOLATILE SOLVENT** on the plastic covers.
- Try to avoid using this equipment on the same power supply as high voltage equipment or equipment likely to cause mains interference.
- Unplug the machine whenever you are working inside it or cleaning it.
- Keep your work environment static free.
- Do not place heavy objects on top of the machine, as these items may become unbalanced and fall causing injury.
- Do not lean against the machine. It may fall on you and could cause injury.
- Unplug the machine when it is not used for a long period of time.
- Place the machine on a stable and level surface.
- Be sure that nothing metallic comes into contact with the metal parts of the unit or connecting plate. If it does, a short may occur and the unit may be damaged.
- Always keep the metal contacts clean.
- Do not apply mechanical shock or drop the unit.

Following information is only for Vietnam:

Declaration of conformity

Toshiba Tec Group Products sold in Vietnam market complies with Circular 16/VBHN-BCT dated April 25, 2014 of the Ministry of Industry & Trade stipulating temporarily the permissible content limitation of some toxic chemicals in the electronic, electrical products.

















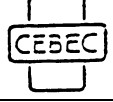

NOTE:

- For indoor use only.
- The unit may become warm whilst in use, this is perfectly normal.

If any difficulty should arise, unplug the unit and contact your authorized Toshiba Tec representative.

When purchasing the power cord:



Since the power cord set is not enclosed in this unit, please purchase an approved one that meets the following standard from your authorized Toshiba Tec representative.

Country	Agency	Certification mark	Country	Agency	Certification mark	Country	Agency	Certification mark
Australia	SAA		Germany	VDE		Sweden	SEMKKO	
Austria	OVE		Ireland	NSAI		Switzerland	SEV	
Belgium	CEBEC		Italy	IMQ		UK	ASTA	
Canada	CSA		Japan	METI		UK	BSI	
Denmark	DEMKO		Netherlands	KEMA		U.S.A.	UL	
Finland	FEI		Norway	NEMKO		Europe	HAR	
France	UTE		Spain	AEE		China	CCC	

Power Cord Instruction

1. For use with 100 – 125 Vac mains power supply, please select a power cord rated Min. 125V, 10A.
2. For use with 200 – 240 Vac mains power supply, please select a power cord rated Min. 250V.
3. Please select a power cord with the length of 2m or less.
4. The power cord plug connected to the AC adapter must be able to be inserted to an ICE-320-C14 inlet. Refer to the following figure for the shape.

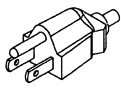
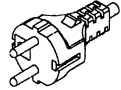
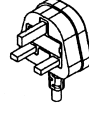

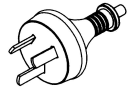
Country/Region	North America	Europe	United Kingdom	Australia	China
Power Cord Rated (Min.) Type	125V, 10A SVT	250V H05VV-F	250V H05VV-F	250V AS3191 approved, Light or Ordinary Duty type	250V GB5023
Conductor size (Min.)	No. 3/18AWG	3 x 0.75 mm ²	3 x 0.75 mm ²	3 x 0.75 mm ²	3 x 0.75 mm ²
Plug Configuration (locally approved type)					
Rated (Min.)	125V, 10A	250V, 10A	250V, *1	250V, *1	250V, *1

*1: At least, 125% of the rated current of the product.

To Charge the Battery Pack

⚠ WARNING

1. The B-EP800-CHG6-QM-R battery charger is designed and manufactured for use with specified lithium-ion battery packs. The battery used in this device may present a risk of fire or chemical burn if mistreated. Do not disassemble, heat above +50degC, or incinerate. Replace battery with specified type only. There is a risk of fire or explosion if the battery is replaced by an incorrect type.

Available Battery Pack	B-EP802-BT-QM-R	B-EP804-BT-QM-R	B-FP803-BT-QM-R	B-FP803-BTH-QM-R
------------------------	-----------------	-----------------	-----------------	------------------

2. Dispose of used battery promptly. Keep away from children. Do not disassemble and do not dispose of in fire.
3. Use only the supplied AC adapter (Model: FSP150-ABAN3) for powering this battery charger.

Please use the following procedure to charge a battery pack. This battery charger can charge six battery packs at the same time with B-EP802-BT-QM-R, B-EP804-BT-QM-R, B-FP803-BT-QM-R and the B-FP803-BTH-QM-R mixed.

1. Fit the partition into the slot. The orientation of the partition differs depending on the battery pack size to be charged.

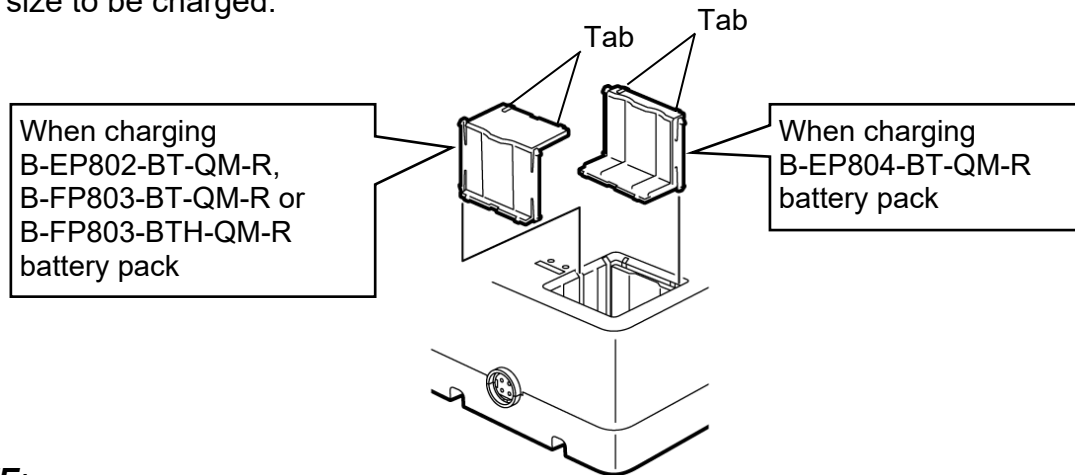

NOTE:

- Fit the partition in the correct position and orientation and make sure the tabs are fit into the holes.
- Be careful not to lose the partition.
- Care must be taken not to mistake the orientation, as the partition cannot be removed once it is fitted.

2. Connect the AC adapter to the battery charger.
3. Connect the power cord to the AC adapter.
4. Connect the power cord to an AC outlet.

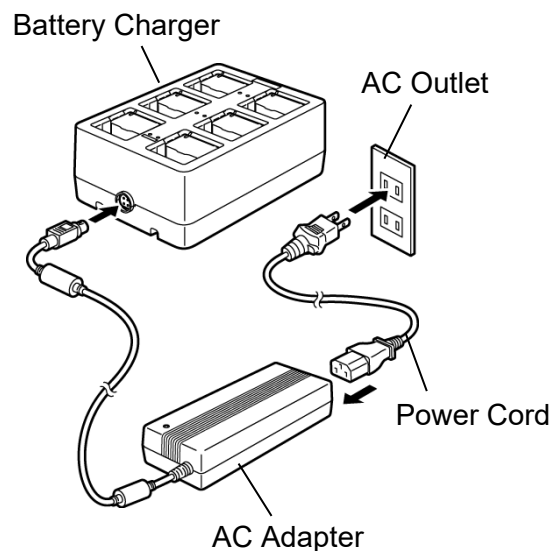

5. Insert the battery pack into the slot in the orientation shown below.
The CHARGE lamp will light up and charging will begin.

NOTE:

- Insert an appropriate size of the battery pack according to the partition's orientation. Failure to do this may damage the battery pack or affect charging operation.
- Place the battery pack firmly.
- Charge the battery pack on a flat, steady surface.

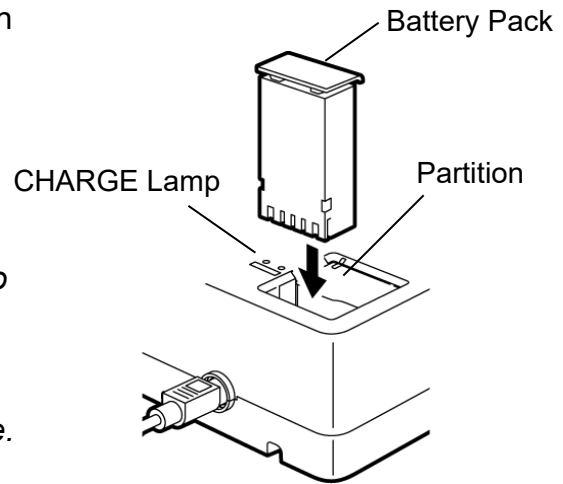

The CHARGE lamp indicates a charging status.

CHARGE lamp	State
OFF	Unconnected.
Red	Charged.
Green	Completed.
Blinking red	Abnormal state

NOTE:

The green light does not go off until the battery pack is removed from the slot.

6. After charging is completed, remove the battery pack from the battery charger.
7. Disconnect the power cord from the AC outlet.

Charging time

To charge an empty battery pack:

Battery pack	Charging time
B-EP802-BT-QM-R B-EP804-BT-QM-R B-FP803-BT-QM-R B-FP803-BTH-QM-R	about 3 hours (Until the min. of 85% of the nominal capacity is charged.)

- Charging time may differ depending on the condition of the battery pack or the operating temperature.
- After the CHARGE lamp turns from red to green, the battery charger may continue to charge the battery pack for up to one more hour until the full charge level (95% or more).

NOTE:

1. Battery packs should be charged on condition that both ambient temperature and battery temperature fall within a range of 0 °C to 40°C.
2. The battery charger will get warmer during charging (room temperature + about 30°C). This is not abnormal.
3. If the over discharge protector has been operated on a battery pack, the CHARGE lamp may not light for a while. Leave the battery charger and the battery pack alone for a few minutes. Stop using the battery pack if the CHARGE lamp does not light at all as the battery pack may be faulty.
4. The battery pack can be removed from the battery charger while charging is in progress. However, the battery lasting time depends on the charging time.
5. After the charging is completed, do not leave the battery pack in the charger too long. The battery pack gradually discharges.
6. Periodically clean the charger terminals with a soft dry cloth.

TROUBLESHOOTING

If you have any problems while using this product, please check the following point first. If a problem cannot be solved by taking actions described below, unplug the battery charger and contact the dealer or an authorized Toshiba Tec service representative for assistance.

Symptom	Cause and resolution
A battery pack is loaded in the battery charger, but the CHARGE lamp does not light up in red.	<ul style="list-style-type: none">• The power cord is not connected properly. ⇒ Firmly connect the power cord to the AC adapter and the AC outlet.• The terminals of the battery charger or the battery electrodes are stained. ⇒ Wipe clean those portions with a soft dry cloth.• You are attempting to charge a battery pack with the over discharge protection activated (The CHARGE lamp may not light up immediately after loading a battery.) ⇒ Leave the battery charger and the battery pack alone for a few minutes. If the CHARGE lamp does not light after all, stop using the battery pack, as the battery pack may be faulty.• The partition is not fitted. ⇒ Fit the partition in the correct orientation.
The CHARGE lamp blinks in red.	<ul style="list-style-type: none">• A battery pack failure is detected. ⇒ It could be the end of battery life. Replace the battery pack with a new one.
Charging time overruns the approximate specified time.	<ul style="list-style-type: none">• Charging time varies depending on the condition of the battery pack, ambient temperature, etc. ⇒ If the battery charger continues charging even after the specified time has passed, stop charging and replace the battery pack with a new one.
Battery pack does not last long time though the battery is fully charged.	<ul style="list-style-type: none">• It could be the end of battery life. ⇒ Replace the battery pack with a new one.
The battery pack cannot be inserted into the slot.	<ul style="list-style-type: none">• The partition is not set completely. ⇒ Fit the partition completely.

Specifications

Item	Battery charger	AC Adapter (Accessory)
Model	B-EP800-CHG6-QM-R (EP800-CHG6)	FSP150-ABAN3
Power requirements	DC +19V, 7.89A (Supplied by the AC adapter)	100 to 240V AC, 50/60 Hz
Output voltage	---	DC+19V, 7.89A
Application	Toshiba Tec battery pack <ul style="list-style-type: none"> • B-EP802-BT-QM-R (7.4V 2600mAh) • B-EP804-BT-QM-R (14.8V 2600mAh) • B-FP803-BT-QM-R which is equivalent to 18650/2S1P(7.4V 2500mAh) • B-FP803-BTH-QM-R which is equivalent to 2S1P/18650(7.2V 2500mAh) or 2S1P21/18650(7.2V 2400mAh) 	Toshiba Battery Charger B-EP800-CHG6-QM-R (EP800-CHG6)
Number of slots	6 slots (Every slot can charge a battery pack independently.) The battery pack model is automatically sensed.	---
Operating temperature	0°C to 40°C (32°F to 104°F)	
Operating humidity	20 to 80% (no condensation)	
Storage temperature	-20°C to 60°C (-4°F to 140°F)	
Storage humidity	10 to 85% (no condensation)	
Dimensions	148 x 77 x 213 mm (w/h/d) (5.83" x 3.03" x 8.39") excluding the projecting parts	72 x 40 x 171 mm (w/h/d) (2.83" x 1.57" x 6.73") excluding the projecting parts
Weight	Approx. 900 g (31.7 oz) (Excluding the accessories)	Approx. 800 g (28.2 oz)
Accessories	AC adapter x 1, Partition x 6, Owner's Manual x 1	

NOTE: Design and specifications are subject to change without notice.

Toshiba Tec Corporation

© 2006-2022 Toshiba Tec Corporation All Rights Reserved
1-11-1, Osaki, Shinagawa-ku, Tokyo 141-8562, JAPAN



PRINTED IN INDONESIA
BU21000800-EN_N3
R211020Y8500-TTEC