

TOSHIBA

TOSHIBA Barcode Printer

Printer Driver

Operating Manual

26th Edition: February, 2023

Toshiba Tec Corporation

TABLE OF CONTENTS

INTRODUCTION	1
1. GENERAL DESCRIPTION	2
1.1 Features	2
1.2 Applicable printers	3
1.3 Notation	4
1.4 Screens used in this document	4
1.5 Trademark and copyright	4
1.6 Operational conditions	5
1.6.1 Operation system	5
1.6.2 Hardware	5
1.7 Cautions for installation (IMPORTANT)	5
2. INSTALLATION PROCEDURE	14
2.1 Preparation for Installation	16
2.2 Installation under Windows	18
2.3 Installation under Windows (USB with Plug & Play Enabled)	28
2.4 Installation under Windows (Parallel Interface with Plug & Play Enabled)	29
2.5 Uninstalling the Printer Driver	30
3. FUNCTIONS	33
3.1 Page Setup Tab	40
3.1.1 Registering a new stock or editing the existing stock	41
3.1.2 Preset	44
3.1.3 Advanced Options	45
3.1.4 Double-sided Printing	47
3.2 Graphics Tab	49
3.3 Stock Tab	50
3.3.1 DB-EA4D Stock Tab	53
3.4 Options Tab	57
3.4.1 Multiple Part Print Area Settings (B-EV4 (203 dpi) only)	58
3.4.2 Ribbon Adjustments	60
3.5 Fonts Tab	61
3.5.1 Bar Code Font	65
3.6 Tools Tab	67
3.7 Designation of Printer Font	77
4. SYSTEM CONFIGURATION	81
4.1 System Configuration Example	82
5. ADDITION AND DELETION OF STANDARD TCP/IP PORT	84
5.1 Addition	85
5.2 Deletion	88
6. APPENDIX	89
6.1 How to Enable Bidirectional Communication Support	89
6.2 Parameter Setting on the Printer	89
6.3 How to Connect the Printer to LAN	91

Introduction

Thank you for purchasing the TOSHIBA barcode printer.

This document gives you a general description of the installation, operation, and functions of the TPCL*-enabled printer driver (BDRV-WBX8-Z31).

The latest printer driver can be downloaded from Toshiba Tec barcode system website at the following URL:

http://www.toshibatec.com/download_overseas/printer/printer_driver/

* TPCL: Abbreviation of TEC Printer Control Language

1. General Description

1.1 Features

This product is a printer driver designed for TOSHIBA barcode printer and used under Windows 10, Windows 11, Windows Server 2012, Windows Server 2016 and Windows Server 2019.

- Enables easy printing from Windows applications.
- Enables a use of the barcode printer just like an office-use laser or ink jet printer, even if you do not know barcode printer specific commands.
- Enables easy setup of the label size, sensors, cut operation, and other functions unique to the barcode printer.
- The host PC is connectable to the printer with RS-232C, Parallel, USB, LAN or Bluetooth.
Note: Usable interface type varies depending on the printer models. For details, refer to the Owner's Manual of the printer. Bluetooth and IrDA are not supported.
- The barcode printer's built-in fonts can be used as well as Windows TrueType fonts.
- Barcodes and 2D codes can be printed only by registering a desired code as a font in the printer driver.

1.2 Applicable printers

B-452-R	B-452-TS-R	B-SX5T (305 dpi)	B-SX5T-TS12-QQ/QQ-US/QP, B-SX5T-TS22-QQ/QQ-US/QP/QM-R
B-852-R	B-852-TS22-QQ/QP-R	B-SX5T-C N (305 dpi)	B-SX5-TS12-CN, B-SX5T-TS22-CN/CN-R
B-EP2DL-G	B-EP2DL-GH20/GH30/GH40-QM-R	B-SX6T (305 dpi)	B-SX6T-TS12-QM-R
B-EP4DL-G	B-EP4DL-GH20/GH30/GH40-QM-R	B-SX8T (305 dpi)	B-SX8T-TS12-QM-R
B-EV4 (203 dpi)	B-EV4D-G, B-EV4T-G	B-EX4T1 (203 dpi)	B-EX4T1-GS12-QM/CN-R
B-EV4 (300 dpi)	B-EV4D-T, B-EV4T-T	B-EX4T1 (305 dpi)	B-EX4T1-TS12-QM/CN-R
B-SA4T (203 dpi)	B-SA4TM-GS12-QM-R, B-SA4TP-GS12-QM-R	B-EX4T2 (203 dpi)	B-EX4T2-GS12-QM/CN-R B-EX4D2-GS12-QQ/QM-R
B-SA4T-CN (203 dpi)	B-SA4TM-GS12-CN-R, B-SA4TP-GS12-CN-R	B-EX4T2 (300 dpi)	B-EX4T2-TS12-QM/CN-R
B-SA4T (300 dpi)	B-SA4TM-TS12-QM-R, B-SA4TP-TS12-QM-R	B-EX4T2 (600 dpi)	B-EX4T2-HS12-QM/CN-R
B-SA4T-CN (300 dpi)	B-SA4TM-TS12-CN, B-SA4TP-TS12-CN	B-462-R	B-462-TS22-CN-R
B-SV4	B-SV4D-QM/QM-R/CGE/CGE-R/CN/ QQ-US B-SV4T-QM-R	B-FV4 (203 dpi)	B-FV4T-GS12/GS14/GS16-QM-R, B-FV4T-GS14/GS16-CN-R, B-FV4D-GS12/GS14/GS16-QM-R, B-FV4D-GS14/GS16-CN-R, B-FV4D-GH14-QM-R, B-FV4D-GL14-QM-R
B-SX4T (203 dpi)	B-SX4T-GS10-QQ/QQ-US/QP, B-SX4T-GS20-QQ/QQ-US/QP/QM-R	B-FV4 (300 dpi)	B-FV4T-TS12/TS14/TS16-QM-R, B-FV4T-TS14/TS16-CN-R, B-FV4D-TS12/TS14/TS16-QM-R, B-FV4D-TS14/TS16-CN-R
B-SX4T-CN (203 dpi)	B-SX4T-GS10-CN, B-SX4T-GS20-CN/CN-R	B-FP3D (203 dpi)	B-FP3D-GH30-QM-R B-FP3D-GH40-QM-R B-FP3D-GS30-QM-R B-FP3D-GS40-QM-R
B-EX6T1 (203 dpi)	B-EX6T1-GS12-QM/CN-R	B-EX6T3 (203 dpi)	B-EX6T3-GS12-QM/CN-R
B-EX6T1 (305 dpi)	B-EX6T1-TS12-QM/CN-R	B-EX6T3 (305 dpi)	B-EX6T3-TS12-QM/CN-R
B-EX4T3 (600 dpi)	B-EX4T3-HS12-QM/CN-R	DB-EA4D	DB-EA4D-GS10-QM-R DB-EA4D-GS12-QM-R
BA410T (203 dpi)	BA410T-GS12-QM/CN-S	BA420T (203 dpi)	BA420T-GS12-QM/CN-S
BA410T (300 dpi)	BA410T-TS12-QM/CN-S	BA420T (300 dpi)	BA420T-TS12-QM/CN-S

B-FP2D (203 dpi)	B-FP2D-GH30-QM-S B-FP2D-GH50-QM-S B-FP2D-GH30-CN-S B-FP2D-GH50-CN-S	BV400 (203dpi)	BV410D-GS02-QM-S BV420D-GS02-QM-S BV420D-GL02-QM-S BV420D-GS02-CN-S BV410T-GS02-QM-S BV410T-GS14-QM-S BV420T-GS02-QM-S BV420T-GS14-QM-S BV410T-GS02-CN-S BV410T-GS06-CN-S BV420T-GS02-CN-S
BV400 (300dpi)	BV410D-TS02-QM-S BV420D-TS02-QM-S BV420D-TS02-CN-S BV410T-TS02-QM-S BV410T-TS14-QM-S BV420T-TS02-QM-S BV420T-TS14-QM-S BV410T-TS02-CN-S BV410T-TS06-CN-S BV420T-TS02-CN-S		

1.3 Notation

- Names of menus, screens, icons, buttons, tabs, and items are enclosed in square brackets ([]).
For example: Click [OK].
- Wordings shown on the computer monitor and the LCD message display of your printer are enclosed in double quotation marks (“ ”).
For example: “ONLINE”.
- Titles of the chapters and sections to be referred to are expressed in bold and italic.
For example: Refer to ***Section 1.1 Features***.

1.4 Screens used in this document

Screens shown in this document are examples used for explaining operations. Unless otherwise specified, an operation system used in this document is Windows. Note that the screens shown may differ depending on your usage environment and conditions.

1.5 Trademark and copyright

Microsoft and Windows are trademarks of Microsoft Corporation in the United States and other countries. Other company and product names may be registered trademarks or trademarks of others. Each company’s registered trademarks and trademarks are not marked with TM or ®. This document uses the following abbreviations.

- Microsoft® Windows® 10 Enterprise, Microsoft® Windows® 10 Professional, Microsoft® Windows® 10 IoT Enterprise and Microsoft® Windows® 10: Windows 10
- Microsoft® Windows® 11 Home, Microsoft® Windows® 11 Pro, Microsoft® Windows® 11 Enterprise, Microsoft® Windows® 11 Education and Microsoft® Windows® 11: Windows 10
- Microsoft® Windows® Server 2012 Standard Edition, Microsoft® Windows® Server 2012 Datacenter Edition, Microsoft® Windows® Server 2012 R2 Standard Edition and Microsoft® Windows® Server 2012 R2 Datacenter Edition: Windows Server 2012
- Microsoft® Windows® Server 2016 Standard Edition and Microsoft® Windows® Server 2016, Datacenter Edition: Windows Server 2016
- Microsoft® Windows® Server 2019 Standard Edition, Microsoft® Windows® Server 2019 Datacenter Edition and Microsoft® Windows® Server 2019 Essentials Edition: Windows Server 2019

1.6 Operational conditions

This product can be used under the following system requirements.

1.6.1 Operation system

Windows 10 (32 bit/64 bit), Windows 11, Windows Server 2012, Windows Server 2016 or Windows Server 2019

1.6.2 Hardware

A DOS/V (IBM AT compatible) machine running the above Windows operation system must be used along with the following mandatory or recommended requirements.

1.7 Cautions for installation (IMPORTANT)

Be sure to read the following cautions before using this product.

- When you are going to install an upgraded version of the TEC printer driver, you must first uninstall the older version in advance. For how to uninstall the printer driver, refer to **Section 2.5 Uninstalling the Printer Driver**.

Failure to do so may cause unstable printing operations due to the influences of the files and registry related to the old version remaining in the system. Follow the procedure in **Section 2.5 Uninstalling the Printer Driver**, and the files and registry related to the printer driver will be deleted from the system.

- Note:**
- This printer driver uses common program for all applicable printer models.
 - Even if the printer model is different, TPCL printer driver of different version cannot be used on the same PC.
 - When installing TPCL printer driver for a new model on the PC in which the TPCL printer driver of different version for another printer model has been already installed, the existing printer driver needs to be deleted.

- Be sure to set [Printer Status Monitoring] as shown in the table below. The status monitor has been disabled as default. Wrong setting disables proper printing.

■ Configuration for the Status Monitor

When [Printer Status Monitoring] is set to other than “Disabled”, it is possible to monitor the printer status from the host computer. When this feature is not supported or is unnecessary, choose “Disabled” for [Printer Status Monitoring]. Doing so reduces the load on the printer driver and increases the print efficiency.

O: Any setting X: Disabled

Conditions Printer model	Interface						
	RS-232C *1 (Serial interface cable)	Parallel (Printer cable) *2 Conforming to IEEE1284 (Compatible/ECP mode)		USB	LAN/WLAN 10BASE-T/100BASE-TX		Bluetooth
	—	Other than the right column	CENTRO.MODE=ECP PLUG&PLAY=ON	Ver1.1 /2.0	Standard TCP/IP Port(RAW)	Other Port	—
B-SX6T (305 dpi) B-SX8T (305 dpi)	O	X	Not supported	O	O	X	X
B-EX4T1 (203 dpi) B-EX4T1 (305 dpi)	O	X	Not supported	O	O	X	X
B-EX4T2 (203 dpi) B-EX4T2 (300 dpi) B-EX4T2 (600 dpi) B-EX4D2 (203 dpi)	O	X	Not supported	O	O	X	X
B-EX6T1 (203 dpi) B-EX6T1 (305 dpi)	O	X	Not supported	O	O	X	X
B-EX6T3 (203 dpi) B-EX6T3 (305 dpi)	O	X	Not supported	O	O	X	X
B-EX4T3 (600 dpi)	O	X	Not supported	O	O	X	X
B-EV4 (203 dpi)	X	X	Not supported	X	X	X	X
B-EV4 (300 dpi)	X	X	Not supported	X	X	X	X
B-FV4 (203 dpi)	X	X	Not supported	X	X	X	X
B-FV4 (300 dpi)	X	X	Not supported	X	X	X	X
B-EP2DL-G	O	Not supported	Not supported	O	O	X	O
B-EP4DL-G	Not supported	Not supported	Not supported	O	O	X	O
B-452-R	O	X	Not supported	O	O	X	X
B-462-R	O	X	Not supported	O	O	X	X
B-852-R	O	X	Not supported	O	O	X	X
B-SA4T (203 dpi), B-SA4T-CN (203 dpi), B-SA4T (300 dpi), B-SA4T-CN (300 dpi)	O	X	Not supported	O	O	X	X
B-SX4T (203 dpi), B-SX4T-CN (203 dpi) B-SX5T (305 dpi), B-SX5T-CN (305 dpi)	O	X	O	O	O	X	X
B-SV4	O	X	Not supported	O	Not supported	Not supported	X
B-FP3D (203 dpi)	X	X	X	O	O	X	O
DB-EA4D	X	X	Not supported	O	X	X	O
BA410T BA420T	O	Not supported	Not supported	O	O	O	O
B-FP2D (203 dpi)	X	X	X	O	O	O	O
BV400 (203 dpi) BV400 (300 dpi)	O	Not supported	Not supported	O	O	O	O

Notes:

1. When RS-232C (Serial interface) is used for connection, it will take time until printing starts. It is recommended to use other interfaces as far as possible.

- Whenever "CENTRO. MODE" is set to "ECP" in the printer system mode, be sure to set "PLUG & PLAY" to ON. And, whenever "CENTRO. MODE" is set to "SPP", be sure to set "PLUG & PLAY" to OFF. ("CENTRO. MODE" and "PLUG & PLAY" have been set to "SPP" and "OFF" as the factory default settings, respectively.)
To enable the bidirectional communication, be sure to set "CENTRO. MODE" to "ECP" and "PLUG & PLAY" to "ON".
For details of the printer parameter setting, refer to **Section 6.2 Parameter Setting on the Printer**.

- If printing is performed with the status monitor enabled though this feature is not available or not necessary, delete the print job and disable [Printer Status Monitoring].
- If you start the status monitor by mistake, close the status monitor and disable [Printer Status Monitoring].
- When the status monitor is used to monitor the printer statuses, do not install more than one printer driver specifying the same output port in one host PC. When more than one printer driver is installed in a PC, disable [Printer Status Monitoring]. Also, when multiple computers connect to the same printer, specify that printer as the shared printer or disable [Printer Status Monitoring].

- When Kanji characters are used as barcode font data, click the [Tool] tab – [Configure] button – [Printer Options], and select "ESC/LF/NUL" for "Control Codes" of "Command Protocol".

Barcode font types that accept Kanji data: PDF417, MicroPDF417, Data Matrix, MaxiCode, QR code

The default setting of "Control Codes" is "Standard".
Be sure to change this setting when you print Kanji characters as barcode data, otherwise an error will result.

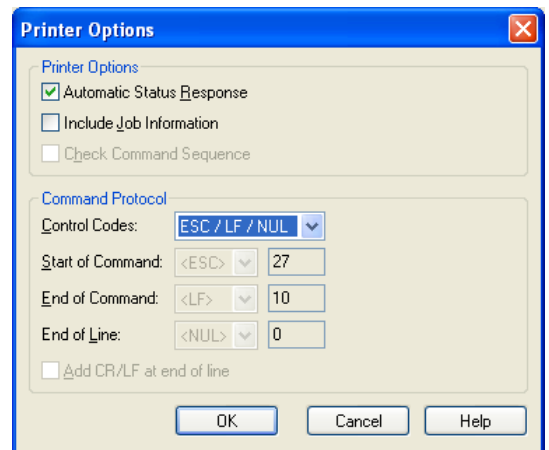

- The default setting of the function character is a caret “^” (5EH). When using barcode fonts like QR code and if you want to specify a function character as barcode data, you need to specify two function characters consecutively.

For example, when a caret “^” is used as the function character, enter “^ ^” as barcode data.

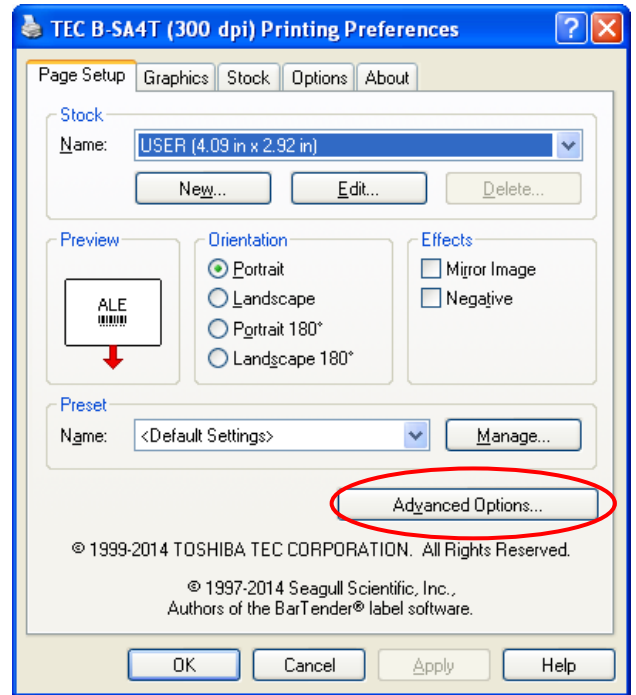

Click the [Page Setup] tab, [Advanced Options], and specify “Function Character”. This is used when binary data is specified as barcode data.

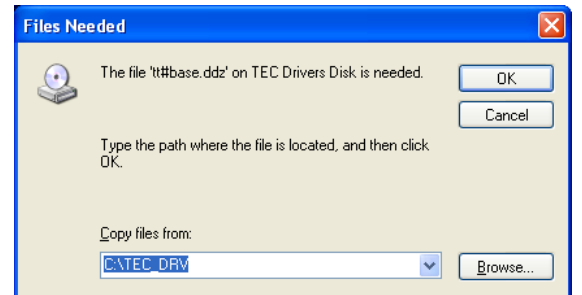
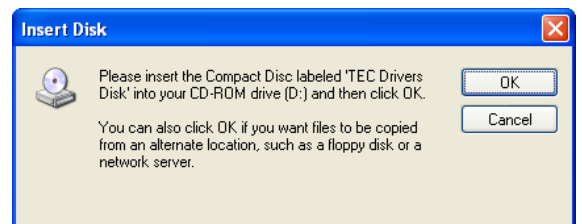
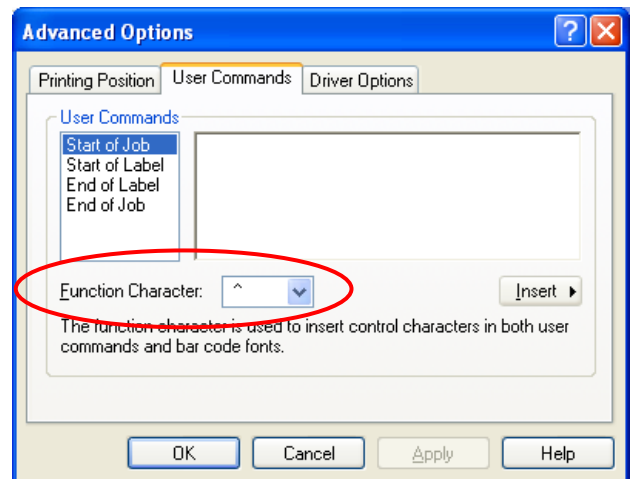

- When using this product for B-EP2DL-G or B-EP4DL-G, set the printer mode to “TPCL-LE”, “TPCL-LE1”, “TPCL” or “TPCL1” by using the Printer Setting Tool or the keys on the printer. For the key operations, refer to the B-EP Series Key Operation Specification.
- When a device font is used, the actual print result looks different from the print preview. Print the label format, and check and adjust the label format.
- RFID fonts are not supported.
- The stock sizes, A4, A5, and A6, shown in this product do not define the paper size in DEVMODE (DMPAPER_A4, DMPAPER_A5, and DMPAPER_A6). They are the stock IDs unique to this product.

The following table shows the stock IDs for the standard stock types registered to the printer driver. When a new stock type is additionally registered, an ID will be assigned in the order of registration, starting from 257. The stock ID can be changed on the Edit Stock screen. Use these IDs when specifying or checking a stock size of dmPaperSize.

Stock name	Stock ID	
	Current	Old
USER	256	256
2x4	32000	257
4x4	32001	258
4x6	32002	259
200x85	32004	260
A4	32005	261
A5	32006	262
A6	32007	263
JAMA L	32010	267
JAMA M	32011	268
JAMA S	32012	269
Form-F	32009	270
Form-A	32008	271
185x85	32003	272
6x4	32013	---
2x2	32014	---
3x3	32015	---

ATTENTION:

The IDs for the standard stock types have been totally changed from Version 7.2 M-2, which causes mismatching in the IDs between the older printer driver and the new printer driver. Therefore, when printing is performed from the application which manages the stock types for Excel, Access, etc. by their IDs assigned by the older printer driver version, a wrong stock may be selected.

In this case, change the stock IDs back to the former ones using the following procedure.

- (1) For the user-added stocks, import the settings of the previous printer driver to the new printer driver. (User-added stocks are imported with their original IDs.)
- (2) For the standard stock types, the stock IDs registered to the new printer driver are unchangeable. So, select the standard stock type, click on the [New], and save it as a new stock assigning the former ID listed the table on the left.

The stock list is sorted by ascending order of stock name (Symbol, number, alphabet, Kana, and Kanji), regardless of the stock ID.

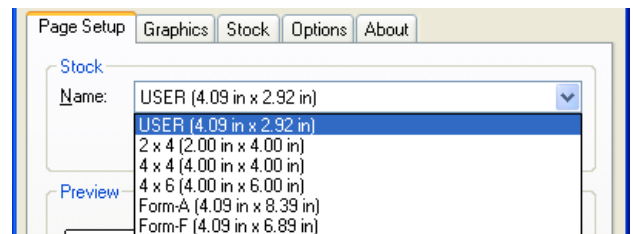

- In the case an export file of the previous version is imported, the preset paper settings may be reset. After importing the preset settings, check the settings.
- When Access2007 is used, some paper names may not be correctly shown. To set the paper names, click [Page Setup] and open the “Edit Stock” dialog.
- For the BA410T series and the BA420T series, the printer performs at 76.2 mm/sec. if 50.8 mm/sec. is specified on the thermal transfer mode.
- Some functions which are not contained in your printer may be displayed on the various setting menus of the printer driver. Those functions are not supported.
- When the port configuration is changed, the dialog box on the right may be displayed. In this case, change the port configuration with administrative privilege.

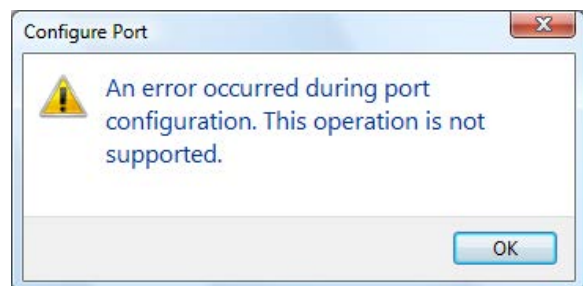

- Bitmap fonts cannot be used for Access. When using Access, remove the check from the “List Bitmap Font” check box in the “Font Settings” dialog.

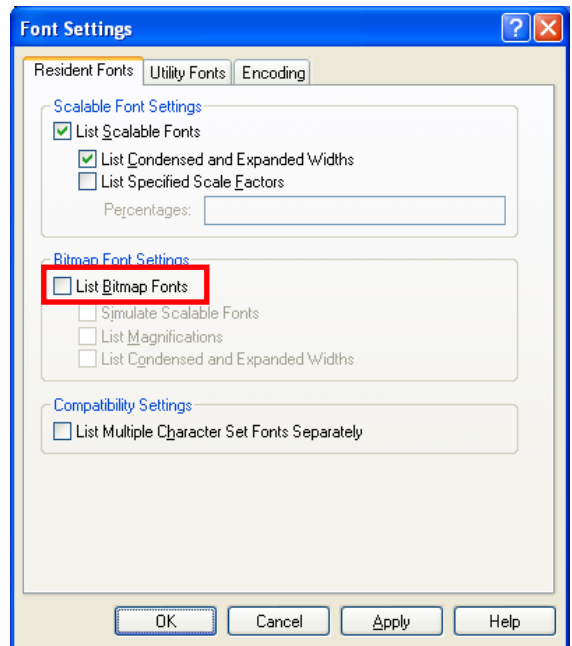

- Do not install other Seagull Scientific printer drivers in the PC where this product has been installed. If you installed any by mistake, uninstall all printer drivers by the DriverWizard, then reinstall this product only.

- When printing is performed from an application created by PrintSystem3 and Active Reports, open the Properties, click the [Advanced] tab, and remove the check from the “Enable advanced printing features” check box. When this check box is selected, the number of prints may not reflect correctly. The default setting after installing the printer driver is enabled. When you remove a check from check box, change the setting after the print system III and Active Reports are completed.

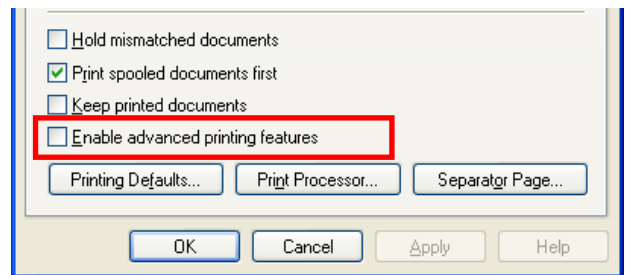

- It will be same operation as [sending print data to the printer after spooling the minute data (T)] in case the [Enable detailed Printing Function] check box is not checked, even if [Send Print Data to Printer immediately (I)] is already set up.

- When data with a large number of digits is encoded into a barcode (or 2D code), and if that barcode cannot be printed within a page width, such data will be invalid. When you use data with a large number of digits, click the [Fonts] tab, select the barcode font, click [Font] and [Edit], then select the “Join Multiple Lines” check box. When this check box is selected, every data specifying the same font will be incorporated into one barcode. If you want to print more than one barcode of the same font with this feature enabled, register required number of barcode fonts.

Example: When you want to print three Code128 symbols in a page with “Join Multiple Lines” enabled, register three Code128 barcode fonts and specify one to one:

- Barfont Code128-1
- Barfont Code128-2
- Barfont Code128-3

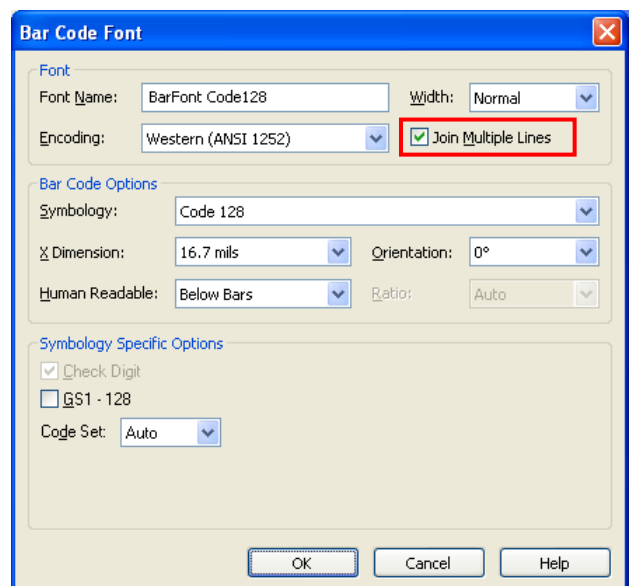

- If data including a space at the beginning or at the end is printed in barcode font, such space is deleted from the data. Multiple data with the same Y-coordinate and same barcode font specified are all connected. To avoid this, click the [Fonts] tab and [Tools], select “Font Settings”, click the [Utility Fonts] tab, then remove the check from the “Combine Adjacent Bar Code & RFID Fields” check box.

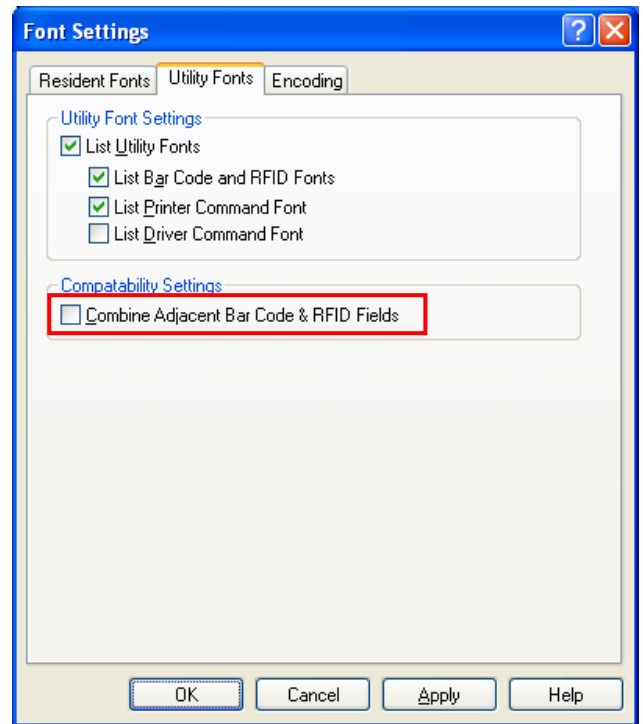

- In the case more than one print job is continuously printed, these jobs may not be printed in the order displayed in the print queue. To avoid this, select the “Print spooled documents first” check box.

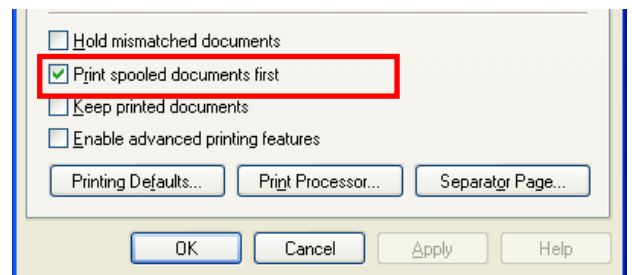

- Changing the printer name with the “Enable bidirectional support” check box unselected may cause the setup information to be non-editable. In this case, select the “Enable bidirectional support” check box and click [OK]. Then open the same screen again and remove the check from the “Enable bidirectional support” check box. It is possible to save the setup information by temporarily enabling the bidirectional support after changing the printer name.

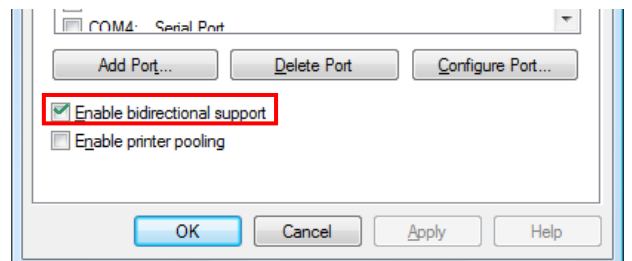

- In the case of Bluetooth communication, click the [Tools] tab [Setting], select "Printer Option", then select the "Bluetooth Connection" check box. Also, select the "Enable bidirectional support" check box in the [Port] tab.

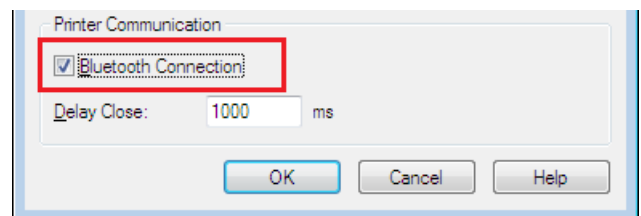

- Together with the above setting, Set "Status Monitoring" as "During print jobs only", "On demand" or "Continuous".
- In case of using the USB connection and cannot open the printer's properties, do below action.
 1. Delete all printers in Driver Wizard and reboot the computer.
 2. Install the printer driver again and add printer.

■ How to open the Properties with the administrative privilege

To change some of the settings, the administrative privilege is necessary depending on the environment. Right-click the printer icon, select “Run as administrator” and click “Properties”.

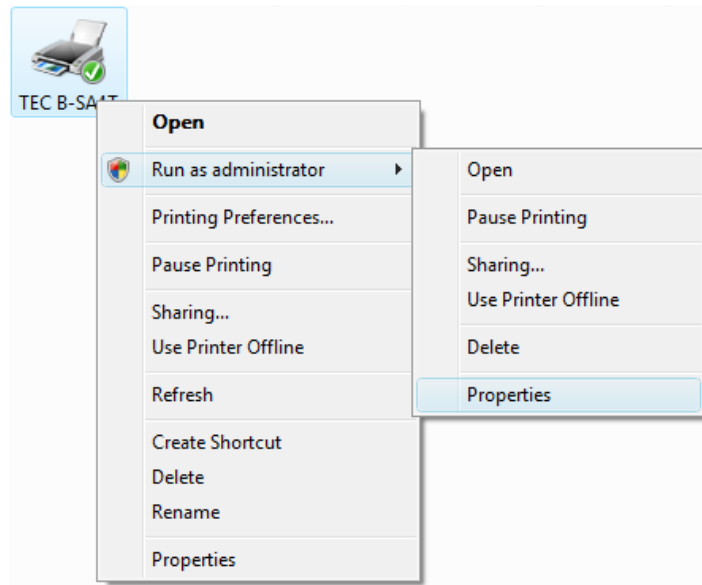

Note: The “User account control” dialog box may be displayed. In that case, click [Allow].

■ How to set up Windows again

If you uninstall the printer driver, set up the Windows again. This should be also conducted when the installation does not succeed.

1. Select “Start”, “All programs”, “TOSHIBA TEC”, “TPCL Printer Driver” and “TECDRVIN”.

Note: Log on as the user with administrative privilege. The “User account control” dialog may be displayed. In that case, click [Allow].

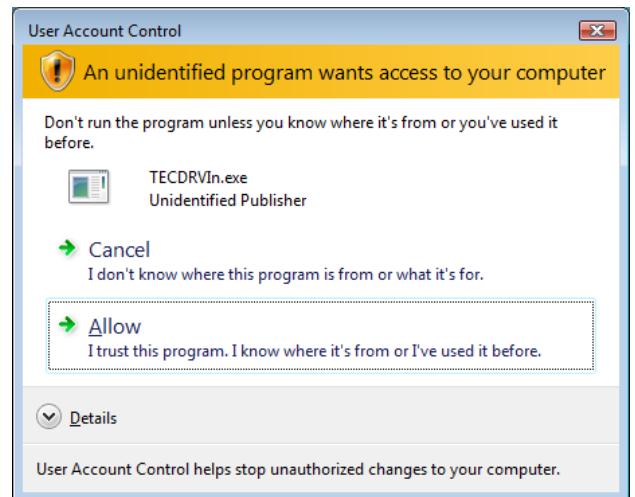

2. When the screen on the right appears, click [Install].

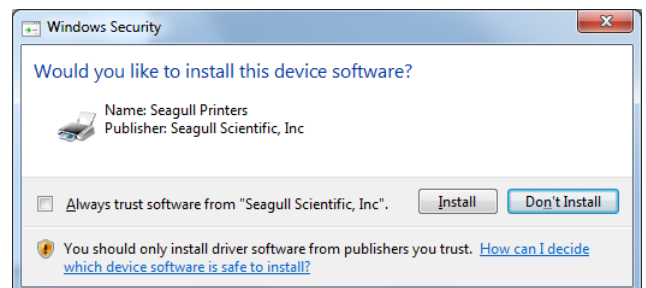

■ If plug-and-play installation fails under Windows

If an undefined device is created after a plug-and-play installation, follow the procedure below.

1. Select “Start”, “All programs”, “TOSHIBA TEC”, “TPCL Printer Driver” and “PnP recovery”.

Note: Log on as the user with administrative privilege.
The “User account control” dialog may be displayed. In that case, click [Allow].

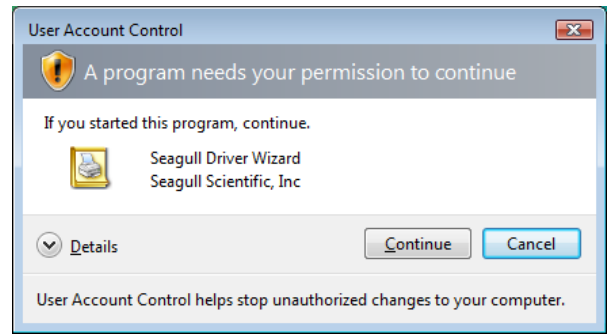

2. When the screen on the right appears, click [Install].

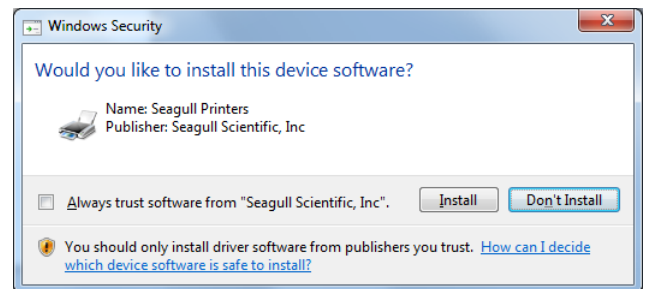

2. Installation Procedure

The installation procedure of this printer driver differs depending on the printer models and the connection methods. Follow the procedure for the appropriate condition to install the printer driver.

If the older version of this printer driver has been already installed, be sure to uninstall it first, restart the printer, and install the latest printer driver.

☞ **Section 2.5 Uninstalling the Printer Driver.**

Preparatory Procedure Common to All Models

Before installing the printer driver, refer to **Section 2.1 Preparation for Installation** and follow the instructions.

■ Printer driver installation method

○: Connectable X: Not connectable

Printer model	Connection method					
	Plug and Play is not used.				Plug and Play is used.	
	RS232C	LAN	Parallel	Bluetooth	USB	Parallel
B-SX8T (305 dpi)	○	○	○	X	○	○
B-SX6T (305 dpi)	○	○	○	X	○	○
B-SV4	○	○	○	X	○	X
B-EV4 (203 dpi), B-EV4 (300 dpi)	○	○	○	X	○	X
B-EP2DL-G	○	○	X	○	○	X
B-EP4DL-G	○	○	X	○	○	X
B-452-R	○	○	○	X	○	○
B-462-R	○	○	○	X	○	○
B-852-R	○	○	○	X	○	○
B-SA4T (203 dpi), B-SA4T-CN (203 dpi), B-SA4T (300 dpi), B-SA4T-CN (300 dpi)	○	○	○	X	○	○
B-SX4T (203 dpi), B-SX4T-CN (203 dpi)	○	○	○	X	○	○
B-SX5T (305 dpi), B-SX5T-CN (305 dpi)	○	○	○	X	○	○
B-EX4T1 (203 dpi), B-EX4T1 (305 dpi)	○	○	○	X	○	○
B-EX4T2 (203 dpi), B-EX4T2 (300 dpi), B-EX4T2 (600 dpi), B-EX4D2 (203 dpi)	○	○	○	X	○	○
B-EX4T3 (600 dpi)	○	○	○	X	○	○
B-EX6T1 (203 dpi) B-EX6T1 (305 dpi)	○	○	○	X	○	○
B-EX6T3 (203 dpi) B-EX6T3 (305 dpi)	○	○	○	X	○	○
B-FV4 (203 dpi), B-FV4 (300 dpi)	○	○	○	X	○	X
B-FP3D (203 dpi)	X	○	X	○	○	X
DB-EA4D	X	○	○	X	○	○
BA410T (203 dpi) BA410T (300 dpi) BA420T (203 dpi) BA420T (300 dpi)	○	○	×	○	○	○
B-FP2D (203 dpi)	X	○	X	○	○	X
BV400 (203 dpi) BV400 (300 dpi)	○	○	×	○	○	○

Note: The above table does not show all interface types that each printer supports.

Check that your actual connection method is ○ (connectable), refer to the **Installation method by operating systems** on the following page, and follow the appropriate installation procedure.

■ Installation method by operating systems

OS	Connection method				Connection method	
	Plug and Play is not used.				Plug and Play is used.	
	RS-232C	LAN	Parallel	Bluetooth	USB	Parallel (*1)
Windows 10	<i>Section 2.2 install under Windows</i>				<i>Section 2.3 Install under Windows (USB connection with plug and play enabled)</i>	<i>Section 2.4 install under Windows (Parallel interface with plug and play enabled)</i>
Windows 11						
Windows Server 2012						
Windows Server 2016						
Windows Server 2019						

*1: If you choose the parallel interface with plug and play enabled, you need to change some parameter settings on the printer. The "plug and play" feature has been disabled as default for the parallel interface connection. See the following.

In the case installing a shared printer, follow the procedure described in "To print on the shared printer" in **Section 2.2 Installation under Windows**. When you want to use Plug and Play, follow the above procedure.

- Printer parameter settings when installing the printer driver via parallel interface with plug and play enabled:

B-SX4 Series and B-SX5 Series

Start the printer in the system mode, enter the <2>PARAMETER SET menu and set the following parameters as below:

CENTRO. MODE: ECP (Default: SPP) Enables an installation of the printer driver with plug and play

PLUG & PLAY: ON (Default: OFF)..... Enables monitoring the printer status. (☞ **Status Window Preferences in Section 3.6 Tools Tab.**)

When you use the bidirectional communication, set "CENTRO. MODE" to "ECP" and "PLUG & PLAY" to "ON", respectively. The parameter setting procedure is provided in **Section 6.2 Parameter Setting on the Printer**.

B-SA4 Series, B-852-R, B-452-R, B-SX6T-R, B-SX8T-R, B-EX4 Series and B-462-R

Start the printer in the system mode, enter the <2>PARAMETER SET menu and set the following parameter:

PLUG & PLAY: ON (Default: OFF)..... Enables an installation of the printer driver with plug and play

Since the printer status monitor cannot be used, disable "Bidirectional support" in the Properties of the printer driver.

2.1 Preparation for Installation

1. Access Toshiba TEC web site at the following address and download the printer driver install file “TPCL*****M*.J.exe” to the local disc.
 1. http://www.toshibatec-ris.com/download_overseas/printer/printer_driver/
 2. **Note:** If you do not agree with the Software License Agreement, you cannot download the file. The * part in the install file name changes depending on the version.
2. Double-click the downloaded “TPCL*****M*.J.exe” and the “TPCL PRINTER DRIVER – InstallShield Wizard” is displayed. Click [Next].

Note: Log on as the user with administrative privilege. When the User Account Control screen is displayed, click on “Allow”.

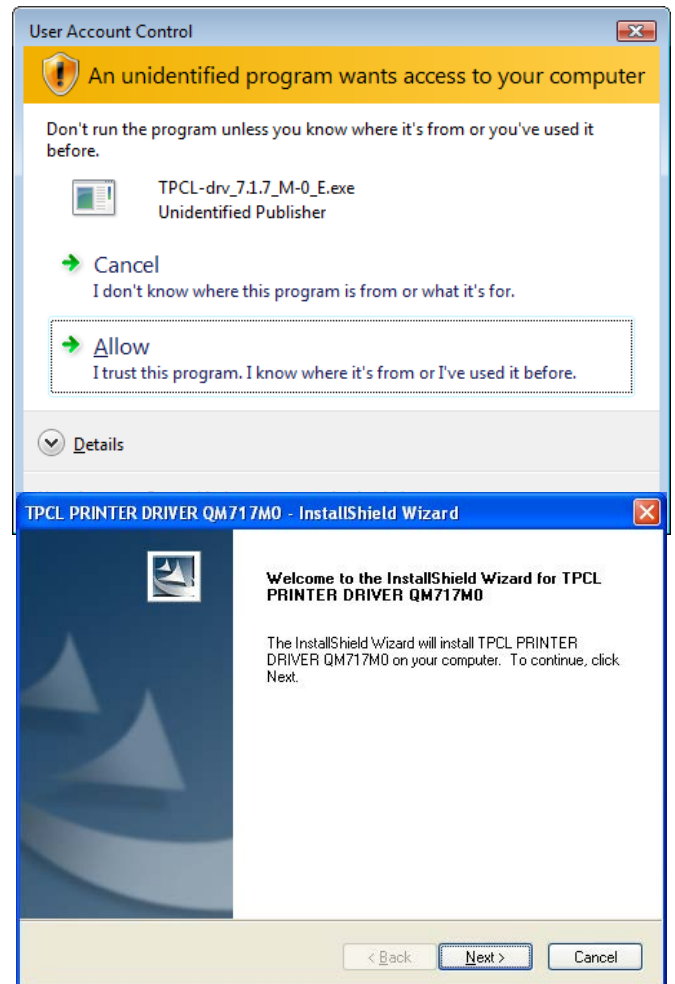

3. The “Software License Agreement” screen is displayed. Select “I accept the terms of the license agreement” and click [Next].

Note: If you do not agree with the Software License Agreement, you cannot download the file.

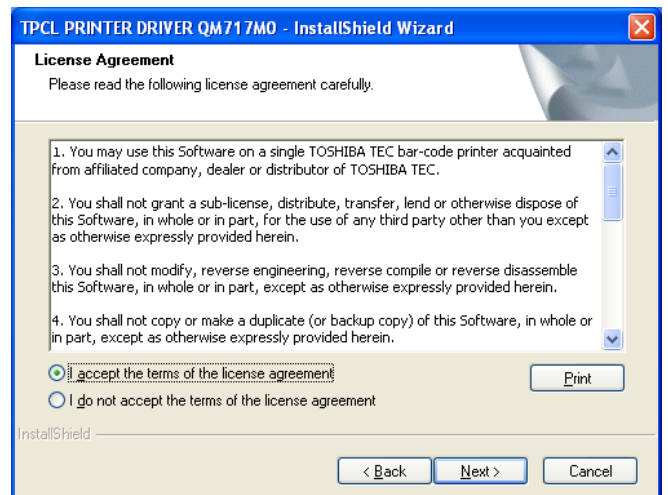

4. When you click [Install], the printer driver install file is created in "C:\TEC_DRV".
Note: The folder name cannot be changed from "C:\TEC_DRV".

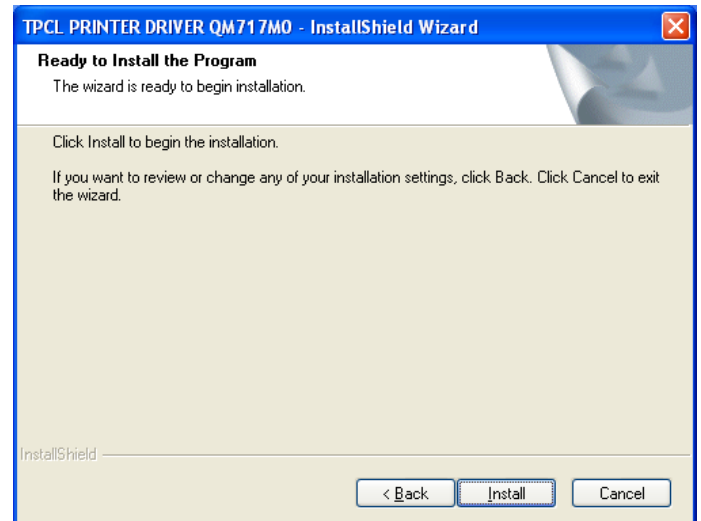

5. When the installation is completed, click [Finish].

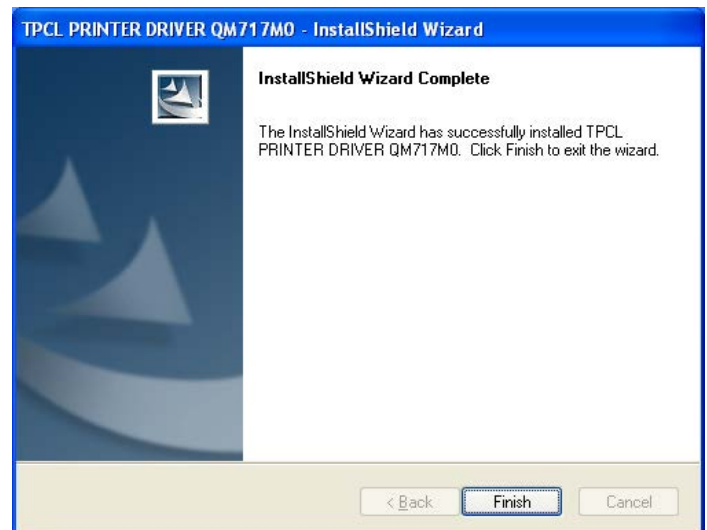

Note: If the right-hand screen appears, click [Install].

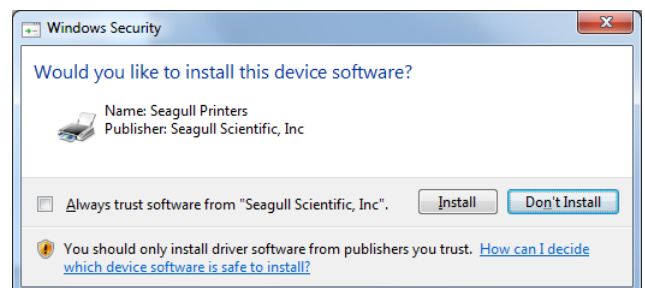

2.2 Installation under Windows

Note: If the installation did not succeed, follow the procedure described in *How to set up Windows again*.

1. Turn on the PC.

Note: Log on as the user with administrative privilege.

2. Select “Start”, “Control Panel”, “Hardware and Sound” and “Printer” to open the printer folder.

Supplement: Entering “Printer” in the Search box of the Start menu causes “Printer” to be shown in the Program.

3. Click “Install a Printer” to start adding a printer.

4. Select “Add a local printer”.

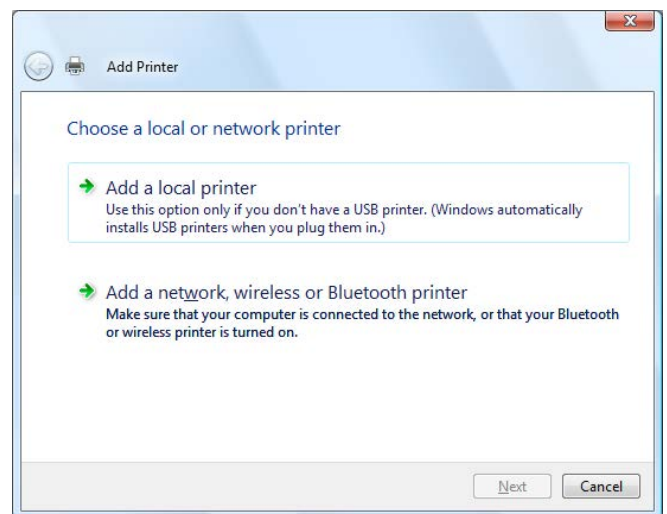

5. Select a printer port and click [Next].

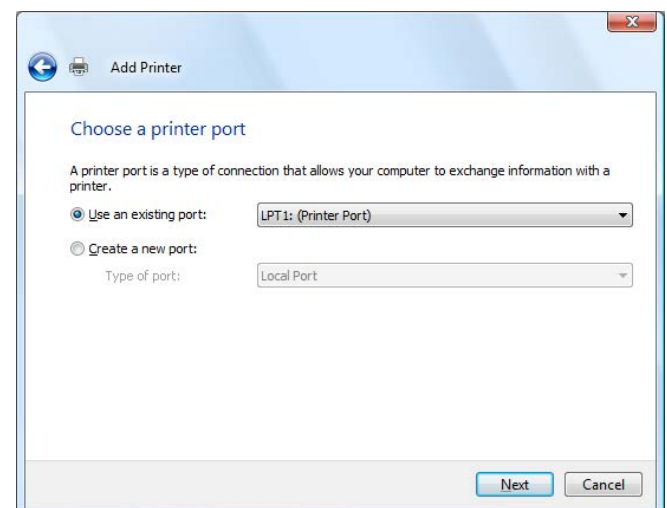

6. When the screen on the right appears, select “TEC” from the Manufacturer list.

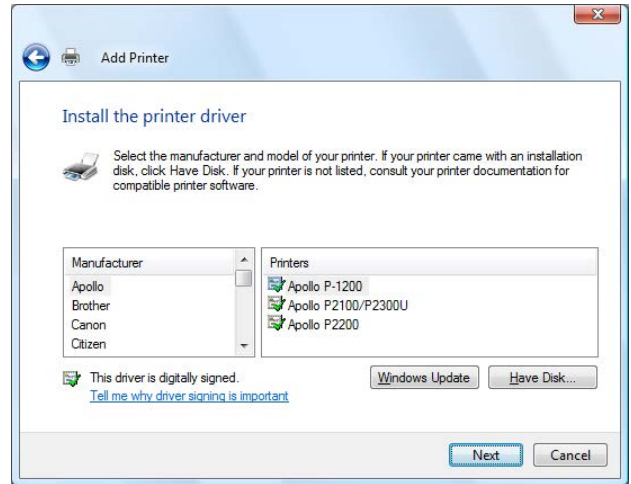

7. The list of the installable printer models is displayed.

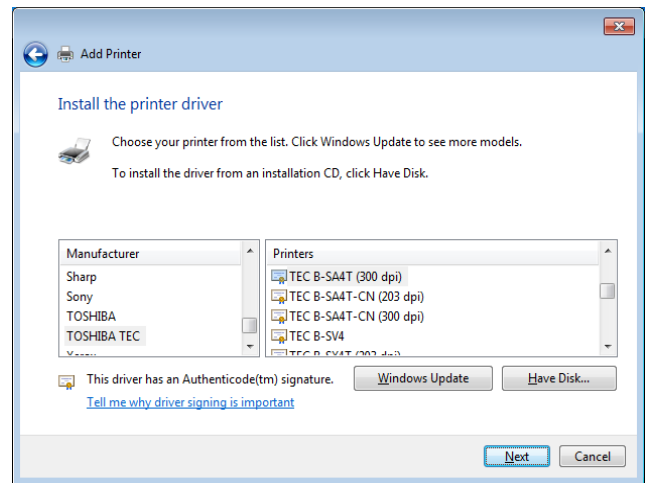

Driver name	Model	Driver name	Model	Driver name	Model
TEC B-852-R	B-852-TS22-QQ-R B-852-TS22-QP-R	TEC B-SA4T (203 dpi)	B-SA4TM-GS12-QM-R B-SA4TP-GS12-QM-R	TEC B-SA4T (300 dpi)	B-SA4TM-TS12-QM-R B-SA4TP-TS12-QM-R
TEC B-SA4T-CN (203 dpi)	B-SA4TP-GS12-CN-R	TEC B-SA4T-CN (300 dpi)	B-SA4TM-TS12-CN B-SA4TP-TS12-CN	TEC B-SV4	B-SV4D-GS10-QM B-SV4D-GC10-QM B-SV4D-GS10-QM-R B-SV4D-GC10-QM-R B-SV4D-GS10-CN B-SV4D-GH10-QQ-US B-SV4T-GS10-QM-R
TEC B-SX4T (203 dpi)	B-SX4T-GS10-QQ B-SX4T-GS10-QQ-US B-SX4T-GS10-QP B-SX4T-GS20-QQ B-SX4T-GS20-QQ-US B-SX4T-GS20-QP B-SX4T-GS20-QM-R	TEC B-SX4T-CN (203 dpi)	B-SX4T-GS10-CN B-SX4T-GS20-CN B-SX4T-GS20-CN-R	TEC B-SX5T (305 dpi)	B-SX5T-TS12-QQ B-SX5T-TS12-QQ-US B-SX5T-TS12-QP B-SX5T-TS22-QQ B-SX5T-TS22-QQ-US B-SX5T-TS22-QP B-SX5T-TS22-QM-R
TEC B-SX5T-CN (305 dpi)	B-SX5T-TS12-CN B-SX5T-TS22-CN B-SX5T-TS22-CN-R	TEC B-SX6T (305 dpi)	B-SX6T-TS12-QM-R	TEC B-SX8T (305 dpi)	B-SX8T-TS12-QM-R
TEC B-452-R	B-452-TS22-QQ/QP-R B-452-TS22-CN	TEC B-EP2DL-G	B-EP2DL-GH20-QM-R B-EP2DL-GH30-QM-R B-EP2DL-GH40-QM-R	TEC B-EP4DL-G	B-EP4DL-GH20-QM-R B-EP4DL-GH30-QM-R B-EP4DL-GH40-QM-R
TEC B-EV4 (203 dpi)	B-EV4D-GS14-QM-R B-EV4T-GS14-QM-R	TEC B-EV4 (300 dpi)	B-EV4D-TS14-QM-R B-EV4T-TS14-QM-R	TOSHIBA B-EX4T1 (203 dpi)	B-EX4T1-GS12-QM-R B-EX4T1-GS12-CN-R
TOSHIBA B-EX4T1 (305 dpi)	B-EX4T1-TS12-QM-R B-EX4T1-TS12-CN-R	TOSHIBA B-EX4T2 (203 dpi)	B-EX4T2-GS12-QM-R B-EX4T2-GS12-CN-R B-EX4D2-GS12-QQ-R B-EX4D2-GS12-QM-R	TOSHIBA B-EX4T2 (300 dpi)	B-EX4T2-TS12-QM-R B-EX4T2-TS12-CN-R
TOSHIBA B-EX4T2 (600 dpi)	B-EX4T2-HS12-QM-R B-EX4T2-HS12-CN-R	TEC B-462-R	B-462-TS22-CN-R	TOSHIBA B-FP3D (203 dpi)	B-FP3D-GH30-QM-R B-FP3D-GH40-QM-R B-FP3D-GS30-QM-R B-FP3D-GS40-QM-R

Driver name	Model	Driver name	Model	Driver name	Model
TOSHIBA B-FV4 (203 dpi)	B-FV4T-GS12-QM-R B-FV4T-GS14-QM-R B-FV4T-GS16-QM-R B-FV4T-GS14-CN-R B-FV4T-GS16-CN-R B-FV4D-GS12-QM-R B-FV4D-GS14-QM-R B-FV4D-GS16-QM-R B-FV4D-GS14-CN-R B-FV4D-GS16-CN-R B-FV4D-GH14-QM-R B-FV4D-GL14-QM-R	TOSHIBA B-FV4 (300 dpi)	B-FV4T-TS12-QM-R B-FV4T-TS14-QM-R B-FV4T-TS16-QM-R B-FV4T-TS14-CN-R B-FV4T-TS16-CN-R B-FV4D-TS12-QM-R B-FV4D-TS14-QM-R B-FV4D-TS16-QM-R B-FV4D-TS14-CN-R B-FV4D-TS16-CN-R	TOSHIBA B-EX6T1 (203 dpi)	B-EX6T1-GS12-QM-R B-EX6T1-GS12-CN-R
TOSHIBA B-EX6T1 (305 dpi)	B-EX6T1-TS12-QM-R B-EX6T1-TS12-CN-R	TOSHIBA B-EX6T3 (203 dpi)	B-EX6T3-GS12-QM-R B-EX6T3-GS12-CN-R	TOSHIBA B-EX6T3 (305 dpi)	B-EX6T3-TS12-QM-R B-EX6T3-TS12-CN-R
TOSHIBA B-EX4T3 (600 dpi)	B-EX4T3-TS12-QM-R B-EX4T3-TS12-CN-R	DB-EA4D	DB-EA4D-GS10-QM-R DB-EA4D-GS12-QM-R	TOSHIBA B-FP2D(203 dpi)	B-FP2D-GH30-QM-S B-FP2D-GH50-QM-S B-FP2D-GH30-CN-S B-FP2D-GH50-CN-S
TOSHIBA BA410T (203 dpi)	BA410T-GS12-QM-S	TOSHIBA BA420T (203 dpi)	BA420T-GS12-QM-S	TOSHIBA BV400(203 dpi)	BV410D-GS02-QM-S BV420D-GS02-QM-S BV420D-GL02-QM-S BV420D-GS02-CN-S BV410T-GS02-QM-S BV410T-GS14-QM-S BV420T-GS02-QM-S BV420T-GS14-QM-S BV410T-GS02-CN-S BV410T-GS06-CN-S BV420T-GS02-CN-S
TOSHIBA BA410T (300 dpi)	BA410T-TS12-QM-S	TOSHIBA BA420T (300 dpi)	BA420T-TS12-QM-S	TOSHIBA BV400(300 dpi)	BV410D-TS02-QM-S BV420D-TS02-QM-S BV420D-TS02-CN-S BV410T-TS02-QM-S BV410T-TS14-QM-S BV420T-TS02-QM-S BV420T-TS14-QM-S BV410T-TS02-CN-S BV410T-TS06-CN-S BV420T-TS02-CN-S

8. Select a model to be installed, then click [Next].

9. Select "Replace the current driver" and click [Next].

Supplement: This step will be omitted when the printer driver is installed for the first time.

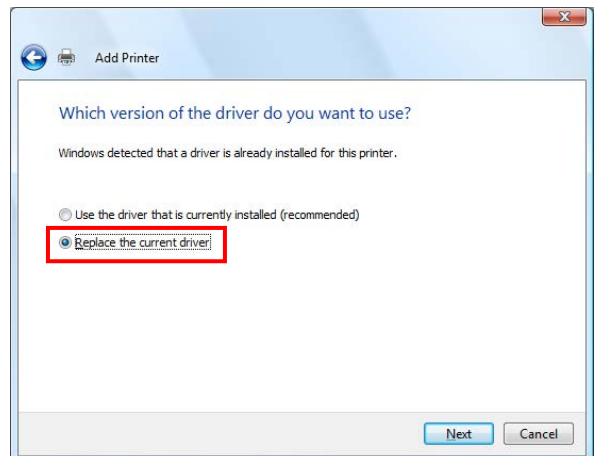

10. Select whether or not to use the printer as a default printer, then click [Next].

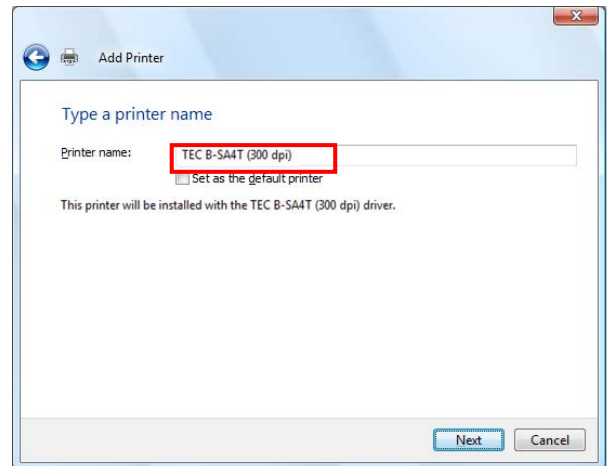

11. Installation starts.

12. When the installation is completed, the "Add Printer" screen is displayed. At this time, a new printer icon is added to the "Printer" folder. Click [Finish]. If you want to perform a print test, click [Print a test page].

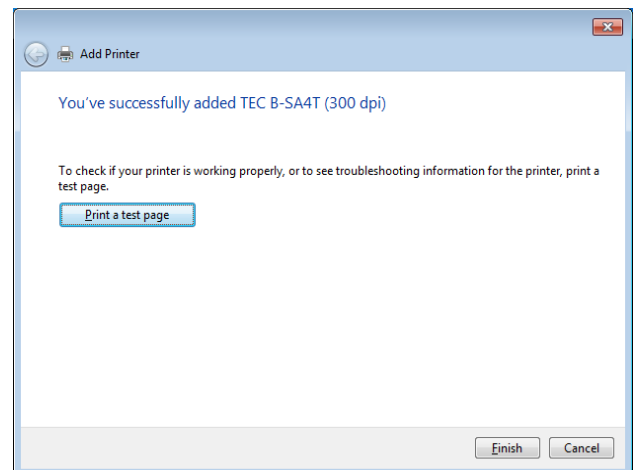

■ To print on the shared printer (1)

1. Conduct above-mentioned steps 1 through 12.

2. Log on as the user which is allowed to access the PC with which the printer is shared.

Note: This work requires the administrative privilege. For the user with no administrative privilege, grant it temporarily.

3. Right-click the newly added icon and select “Properties” to open the “Properties” screen.

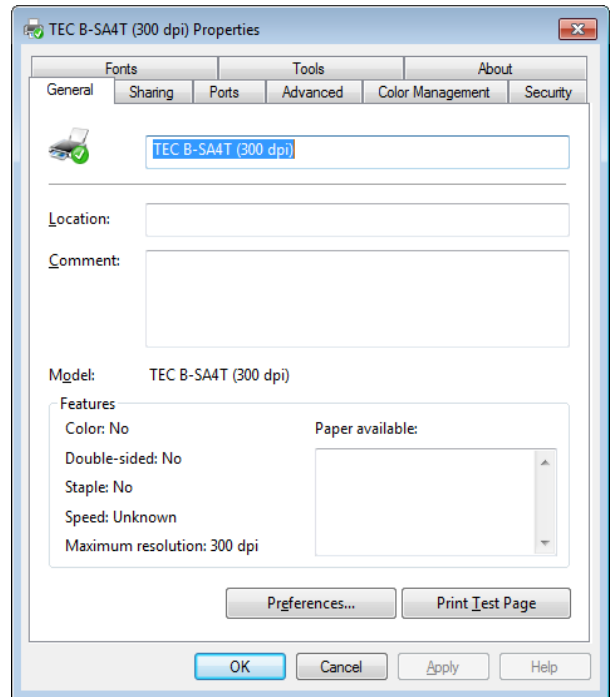

4. Click the “Ports” tab and remove the check from the “Enable bidirectional support” check box. Click [Add Port].

Note: After installing this printer driver, be sure to disable the bidirectional support. For details, refer to **Section 6.1 How to Enable bidirectional Communication Support**.

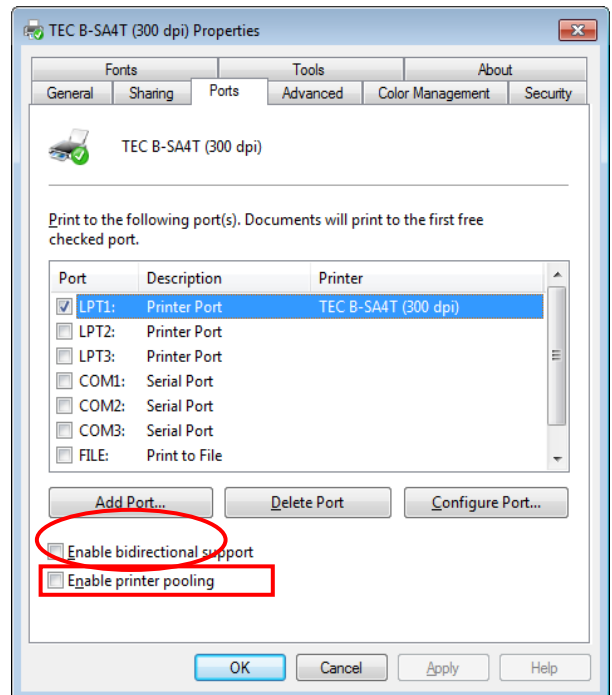

5. Select “Local Port” and click [New Port].

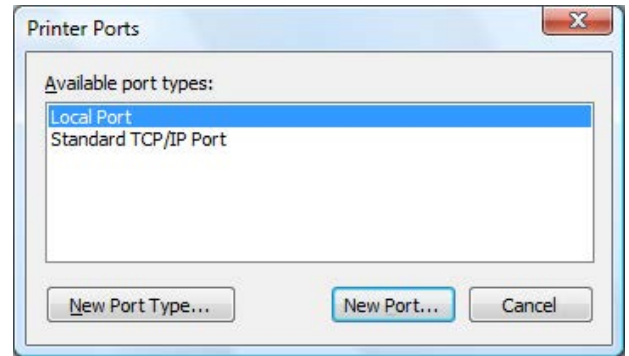

6. Enter the network path of the shared printer (e.g.: *****\TECB-SA4), then click [OK].

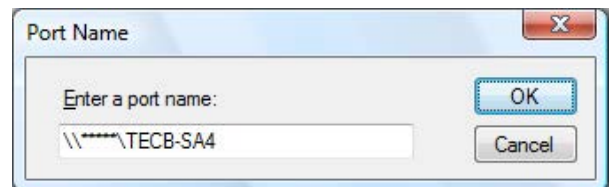

7. When the port setting is completed, click [OK] to close the “Properties” screen.

Note: After installing this printer driver, be sure to disable the bidirectional support. For details, refer to **Section 6.1 How to Enable bidirectional Communication Support.**

Since the setup information is stored in each PC that shares the printer, configure the printer driver settings after the completion of the port setting.

■ To print on the shared printer (2)

Note: If the printer driver of different version has been already installed, first uninstall it, then install this printer driver. The version of the printer drivers in the server PC and client PC must be the same.

◆ Read before installation

The printer driver installed in the server PC must support Windows.

For the client PC, the printer driver needs to be installed in or uninstalled from each user account.

Configure the network settings for the Server PC's shared printer driver, as shown in the screen on the right.

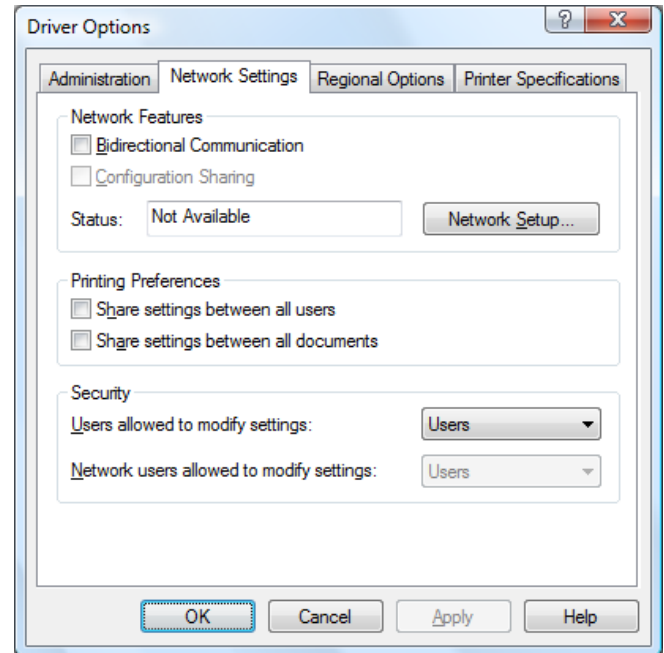

1. Turn on the PC.
Note: Log on as the user with administrative privilege.
2. Follow the procedure described in **Section 2.1 Preparation for Installation**.
3. Log on as the user which is allowed to access the PC with which the printer is shared.
4. Select "Start", "Control Panel", "Hardware and Sound" and "Printer" to open the printer folder.
Supplement: Entering "Printer" in the Search box of the Start menu causes "Printer" to be shown in the Program.
5. Click "Install a Printer" to start adding a printer.

6. Select “Add a network, wireless or Bluetooth printer”.

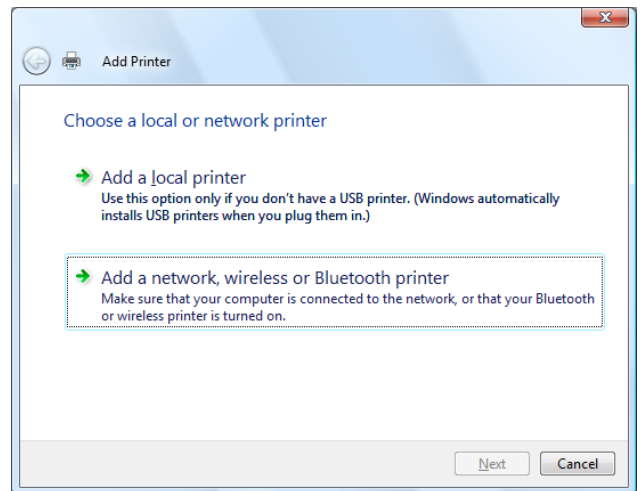

7. Click “The printer that I want isn't listed”.

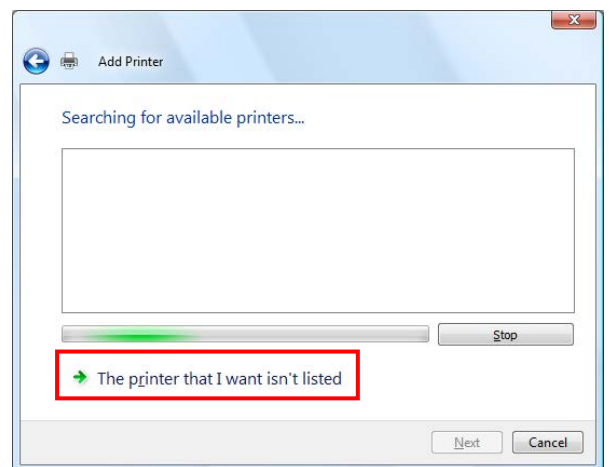

8. Click “Select a shared printer by name”, enter the network path of the shared printer (e.g.: *****\TECB-SA4), then click [OK].

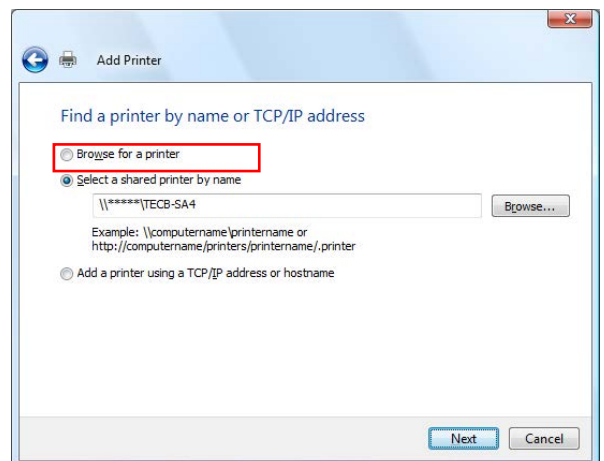

9. Installation starts.

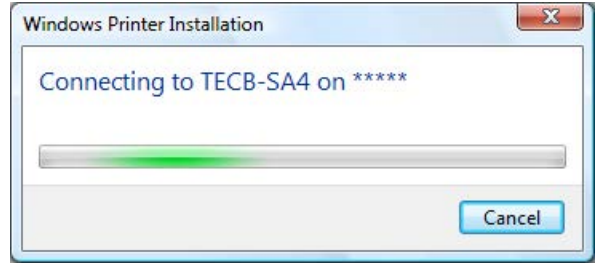

Supplement: If the dialog box on the right appears after the installation, click [Disable].

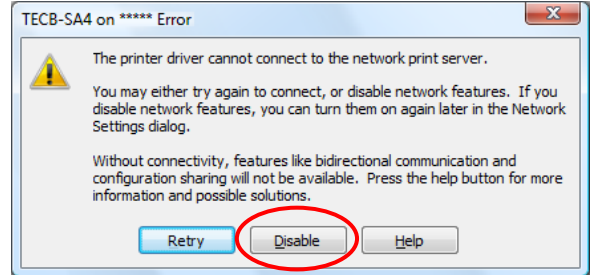

10. Select whether or not to use the printer as a default printer, then click [Next].

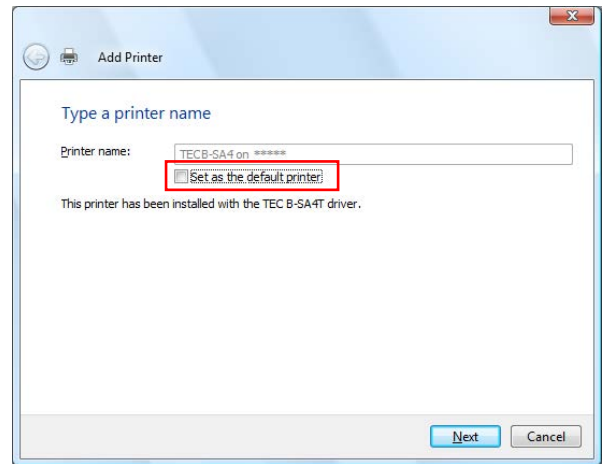

11. When the installation is completed, the screen on the right will appear. At this time, a new printer icon is added to the "Printer" folder. Click [Finish].
If you want to perform a print test, click [Print a test page].

Note: Since the setup information is stored in each PC that shares the printer, configure the printer driver settings after the completion of the port setting.

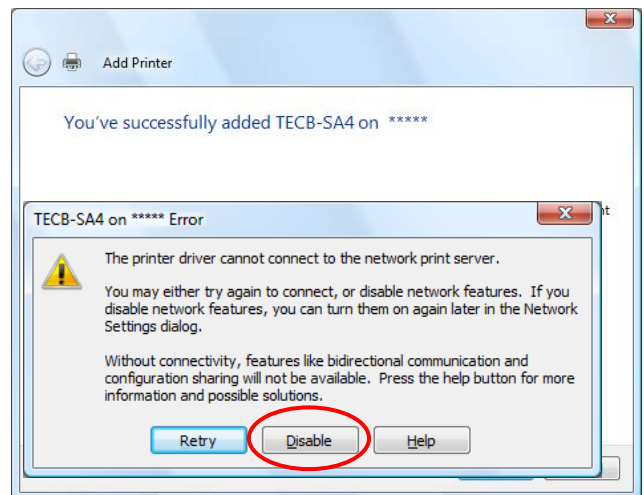

In case of not success the added the printer, try to choose “The printer that I want isn’t listed” in Printer & scanners to install the printer.

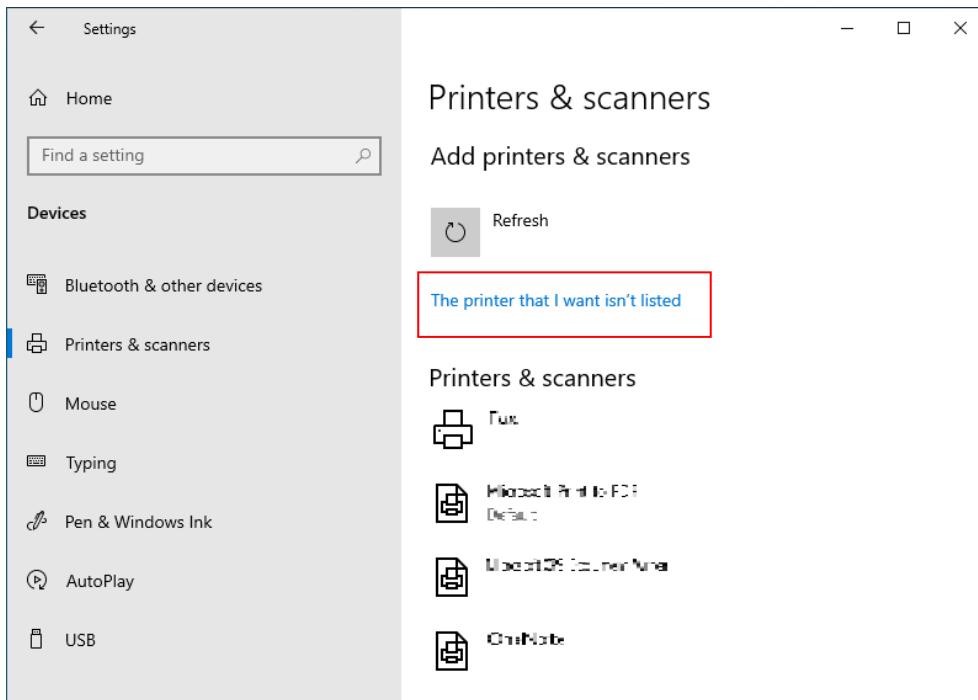

2.3 Installation under Windows (USB with Plug & Play Enabled)

Note: If an undefined device is created after installation of the printer driver, follow the procedure described in the section *If plug-and-play installation fails under Windows*.

1. Turn on the PC.
Note: Log on as the user with administrative privilege.
2. Turn on the printer and connect it to the PC with a USB cable.
3. Installation of the device driver software is automatically started.
4. After a while, the printer driver installation is completed.
5. When the installation is completed, a new printer icon is added to the Printer folder.

2.4 Installation under Windows (Parallel Interface with Plug & Play Enabled)

Note: If an undefined device is created after installation of the printer driver, follow the procedure described in the section *If plug-and-play installation fails under Windows*.

1. Connect the printer to the PC with a parallel interface cable.
2. Turn on the printer.
3. Set the printer parameters in the system mode.

B-SX4 Series and B-SX5 Series

CENTRO. MODE → ECP

PLUG & PLAY → ON

B-SA4 Series, B-852-R, B-452-R, B-SX6T (305 dpi), B-SX8T (305 dpi), B-EX4 Series, B-EX6 Series and B-462-R

PLUG & PLAY → ON

Note: For the parameter setting procedure, refer to **Section 6.2 Parameter Setting on the Printer**.

4. Turn on the PC.
Note: Log on as the user with administrative privilege.
5. After the system is started, the installation of the device driver software is automatically started.
6. After a while, the installation of the printer driver is completed.
7. When the installation is completed, a new printer icon is added to the Printer folder.

2.5 Uninstalling the Printer Driver

To delete the printer drivers

In the following cases, be sure to uninstall the printer driver using the procedure below.

- When the same version is installed again.
- When an older version has been already installed.
- When the installation is canceled on the way or when [No] is selected at a confirmation of the digital signature.
- When the printer driver cannot be installed for some reason.

Notes: 1. When installing the printer driver with Plug & Play enabled, turn OFF the printer first.
2. When the printer driver is deleted, the information of the registered stocks and barcodes are also deleted. This information can be saved in a file beforehand by using the export function and restored by using the import function after re-installation of the printer driver.

● In the case of deleting the printer drivers except for the same version

Before deleting the printer driver except for the same version, follow the procedure described in *Section 2.1 Preparation for Installation*. Doing this causes the previously installed printer driver to be updated and creates the shortcut of the Driver Wizard in the TPCL Printer Driver of the TOSHIBA TEC folder. For such versions, first delete the “C:\TEC_DRV” folder, then conduct the Preparation for Installation. When the preparation is completed, the “Driver Wizard” shortcut is created in the TPCL Printer Driver folder.

● In the case of deleting the printer driver of “To print on the shared printer (2)”

Before deleting the printer driver, delete the printer icon that was created when the shared printer was installed.

● Uninstalling the printer driver

1. Select “Start”, “All programs”, “TOSHIBA TEC”, “TPCL Printer Driver” and “Driver Wizard”.

Note: Log on as the user with administrative privilege. Exit all Windows applications before performing the above operation. Confirm that there is no print job in the spooler, then close the spooler and the printer folder.

In the case of Windows Vista / Server 2008 / 7 / Server2008R2 / 8 / Server2012 / Server2012R2 / 10 / Server2016, the User Account Control screen may appear. In that case, click [Allow].

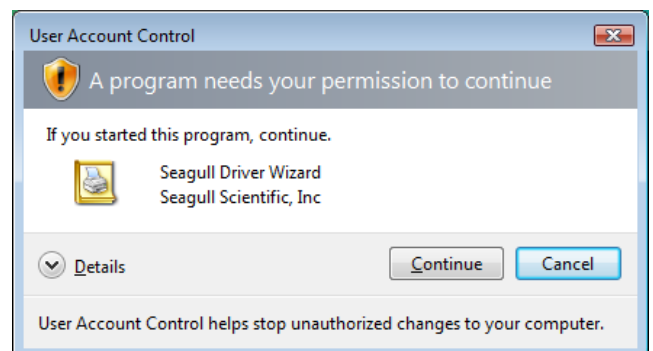

2. Select "Remove printer drivers" and click [Next].

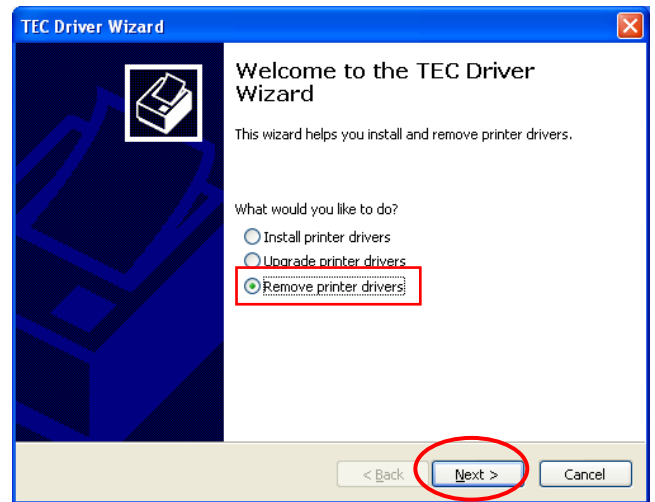

3. Select "Automatically remove all TEC Printer Drivers" and click [Next].

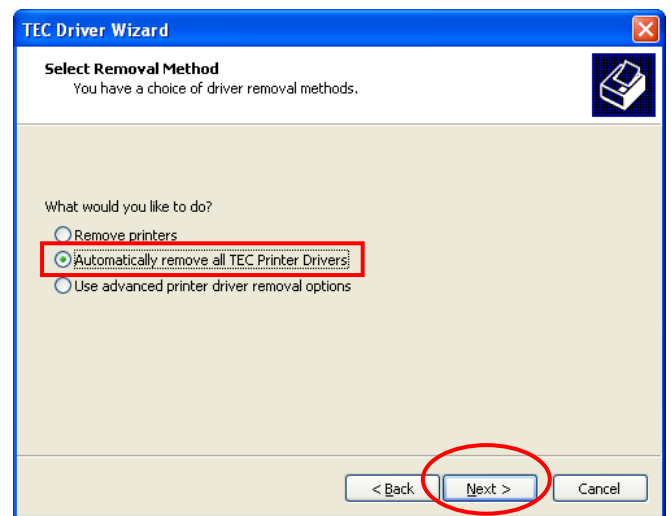

4. Click [Finish] to start to delete the printer drivers.

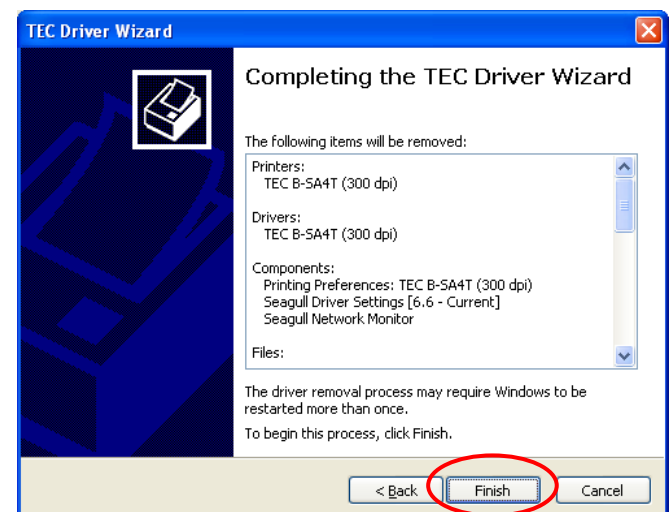

5. When the printer driver is deleted successfully, the screen on the right is displayed.

Note: If the deletion of the printer driver failed, retry from Steps 1 to 5 until the deletion succeeds.

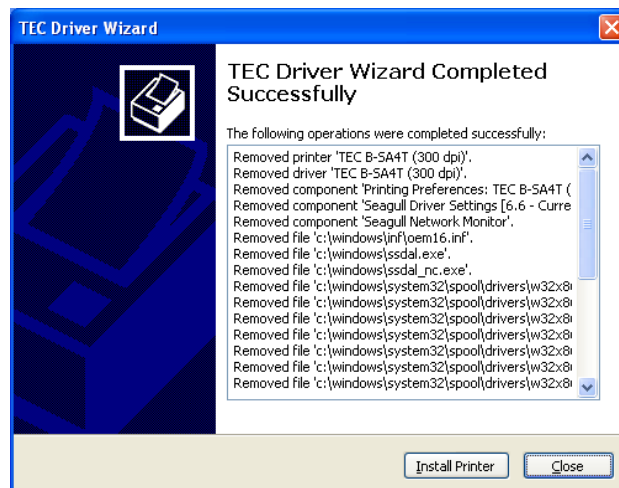

Note: When you deleted the printer driver from Windows 10, Windows Server 2012 and Windows Server 2016 and reinstall the printer driver again, follow the procedure described in **How to Setup Windows again**.

In the case a network printer has been installed in multiple user accounts under Windows 10, Windows Server 2012 and Windows Server2016, it is not possible to delete the printer driver. First, delete the printer icon from each user account, then delete the printer driver.

● Deleting the setup information configured during the preparation

1. Select "Start", "Control Panel" and "Add/Remove Programs".
Note: Log on as the user with administrative privilege.
2. Select "TPCL Printer Driver V2020.1 M-1 (version)" or "TEC Printer Driver Install file" from the list, then click [Delete].
3. When the confirmation message is displayed, click [Yes].
4. When the "Uninstall completed" screen appears, click [Finish].

3. Functions

You can set various functions of this printer driver in “Properties” and “Printing Preferences”. Some functions which are not contained in your printer may be displayed on the various setting menus of the printer driver. Those functions and the ones not listed in the table below are not supported.

■ Property setting menus in the “Printing Preferences”

Right-click the printer icon and select “Printing Preferences”.

The following tabs are provided.

3.1 Page setup

3.2 Graphics

3.3 Stock

3.4 Options

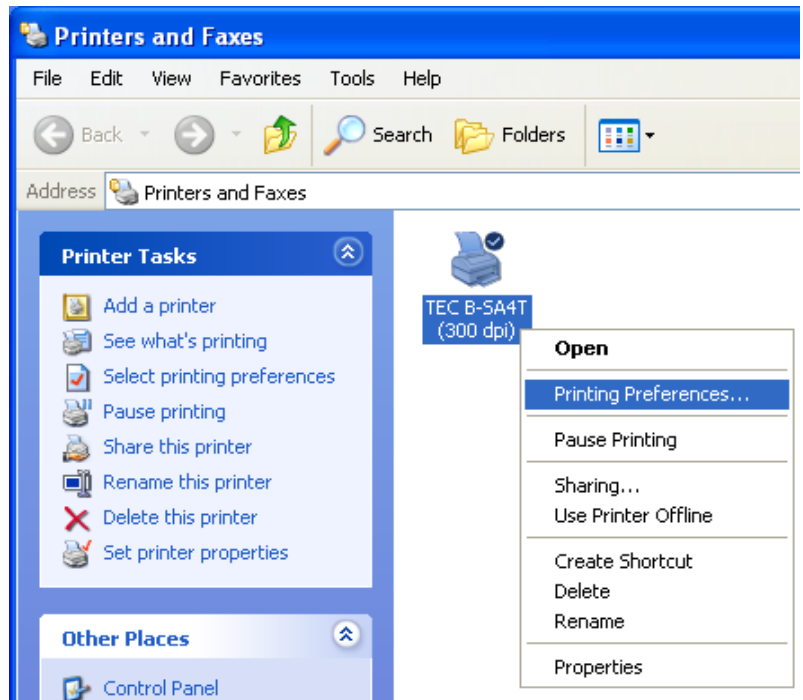

○: Fully supported. X: Use the default.

Function	Description	Support	
Page Setup tab	Stock	○	
	Orientation	○	
	Effects	<Mirror image> When enabled, the print will be a mirror image.	○
		<Negative> When enabled, the print will be white on black. When disabled, the print will be black on white.	
	Preset	Allows saving the settings of this printer driver such as fine adjustment values. When a preset setting file is selected, the current settings will be replaced by the settings of that preset file.	○
	Advanced Options		
	Printing position tab	<Position Adjustment> Allows specifying the offset in horizontal and vertical directions.	X
<Default Orientation> Allows selecting the default print orientation between 0° (bottom first) and 180° (top first).		X	
User Commands tab	<User Commands> Allows setting the printer command to be sent at the start and the end of the job or at the start and the end of the label in the print job.	○	

Function	Description	Support
	<Function character> Allows inserting binary data in barcode font.	○
	Driver Options tab <Device Line Substitution> When enabled, the driver will try to use the printer's Line Commands to draw lines. When disabled, lines are drawn by using the Graphic Command.	○
	<Default Copies> Allows setting the number of copies to be printed as default. If the number of copies is not changed in the application, this value will be effective.	○
	<Disable Copies Limit> When enabled, a value exceeding "9999" can be set for "Default Copies".	X
	<Disable User-Defined Paper Size> When this check box is checked, the paper size will be organized in each printer driver.	○
	<Disable Page Size Sharing> When enabled, paper size will be managed for each printer driver.	○
Graphics tab	Resolution	○
	Dithering	○
	<Color Adjustment> Allows the flip horizontal, flip vertical, rotation, color balance adjustment, etc.	○
	<Dithering Setup> Allows detailed setting for the selected dithering method.	○
	Color	○
Stock	Media settings	○
	<Print Method> Allows selecting whether the ribbon is used (thermal transfer) or not (Direct thermal).	○
	<Sensor> Allows selecting a sensor type used to detect a print start position.	○
	<Label Gap> Allows setting the length of the gap between labels.	○
	Issue Settings	○
	<Issue Mode> Allows selecting whether the labels are issued in the strip mode.	○
	<Post-Print> Allows selecting whether the labels are issued in the cut mode. Note that the Pause is not supported.	○
	<Occurrence> Allows selecting the cutter operation and specifying how often labels should be cut.	○
<Interval> Specifies the number of labels to be printed before a cut operation. The cutter will cut labels after the specified number of labels is printed.	○	
<Print Speed> Allows setting the print speed.	○	

	Function	Description	Support
	Fine Adjustment	<Feed> Specifies the length of label that will feed after printing.	○
		<Backfeed> Specifies the length of label stock that is retracted before printing. This entry window is only available in cut or strip mode.	○
		<Cut/Strip> For the cut issue, specifies the length of label to feed before cutting the label. For the strip issue, specifies the length of label to feed before peeling the label.	○
		<Print Shrinkage> Used to compensate for label print shrinkage or expansion.	○
Options tab	Graphic Options	<Transfer Mode> Allows selecting the method used to download graphics to the printer.	○
	Print Density Adjustment	<Direct thermal> Allows adjusting the print density for the direct thermal mode.	○
		<Thermal transfer> Allows adjusting the print density for the thermal transfer mode.	○
		<Optimization> Allows selecting the printer's optimization level from Quality, Balanced (middle), and Speed. This feature is provided only for the B-EP series.	○
	Feed Adjustment	<Feed Adjustment> Specifies the length of label to feed after printing (feed). Before a next printing is started, the label is fed in the reverse direction to the print start position.	○
	Supply Options	Allows setting the printing energy for each of the direct thermal and thermal transfer.	○
	Multiple Part Print Area	Allows specifying the duplicate printing area and the print density for that area. (B-419 and B-EV4 only)	○
Ribbon Adjustments	Used to set the conditions related to the ribbon.	○	
About tab	License	Shows the license information.	○
	Version	Shows the driver version, settings, and PC information. The shown information can be stored in a file.	○

■ Property setting menus in the “Properties”

Right-click the printer icon and select “Properties”.

3.5 Font

3.6 Tools

3.7 Printer font

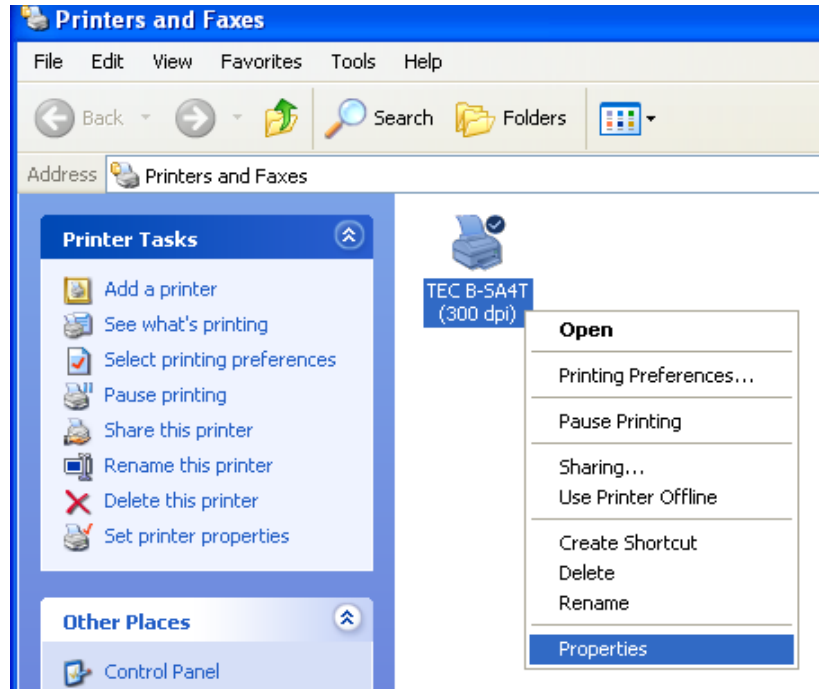

O: Fully supported. X: Use the default.

Function		Description	Support
Font tab	[Font] button	Allows adding, modifying and deleting the currently defined barcode fonts. RFID fonts are not supported.	O
	[View] button	Allows limiting the view of barcode fonts to only those of specified type.	O
	[Tool] button		
	Font settings [Resident Fonts]	<List Scalable Fonts> When selected, the scalable fonts are usable.	O
		<List Condensed and Expanded Widths> When selected, the fonts of which character width is condensed or expanded are usable.	O
		<List Specified Scale Factors> When selected, the fonts of which character width is scalable at any scale ratio are usable.	X
		<Percentages> Allows specifying the scale ratio.	X
		<List Bitmap Fonts> When selected, the bitmap fonts are usable.	O
		<Simulate Scalable Fonts> When selected, the bitmap fonts of same size with the outline fonts are specified.	X
		<List Magnifications> When selected, the magnified fonts are usable.	O
<List Condensed and Expanded Widths> When selected, the fonts of which character width is condensed or expanded are usable.	O		

Function		Description	Support	
		<List Multiple Character Set Fonts Separately> When selected, print fonts are printed with different code page.	X	
	[Utility Fonts]	<List Utility Fonts> When selected, the utility fonts are usable.	○	
		<List Bar Code and RFID Fonts> When selected, barcode fonts and RFID fonts are usable. At present, RFID fonts are not supported.	○	
		<List Printer Command Font> When selected, specified data are sent to the printer as they are.	○	
		<List Driver Command Font> When selected, the font which converts the data in the specified format into a command is usable.	X	
		<Combine Adjacent Bar Code & RFID Fields> When selected, the characters are combined if the same barcode font is specified for them.	○	
	[Encoding]	Allows specifying the method of encoding the data into barcodes.	X	
Bitmap Font Settings	Refer to the Driver Option of the [Tool] tab.	---		
Tool tab	[Print]	Allows performing print tests.	○	
	[Action]	<Form Feed> The printer feeds one label.	○	
		<Cut> The printer cuts the label immediately.	○	
		<Read Printer Information> Shows the printer version and option information obtained from the printer.	X	
		<Manage XML Print Files> Allows managing the files of label formats, graphics, and fonts stored in the printer.	X	
		<Reset Printer> Resets the printer.	○	
		<Test Print Head> Allows execution of the printer's broken element test.	○	
		<Send Printer Command> Sends the generated printer commands to the printer. When the bidirectional communication is enabled, the printer status is obtained and shown after sending the commands.	○	
		<Send File To Printer> Sends the command file to the printer.	○	
	[Configure]	Printer Options	<Automatic Status Response> When selected, the printer status is automatically sent at the end of a job or the occurrence of an error.	○
			<Include Job Information> When selected, the job information obtained from the printer via SNMP is included in the print job.	○

Function	Description	Support
	<Check Command Sequence> When selected, a command, which checks whether any command is missing from a command string the printer received, is attached.	○
	<Command Protocol> Specifies the command control code.	○
	<Bluetooth Connection >	○
	<Delay Close>	○
	<Auto Feed Setting> Allows selecting whether to enable or disable the auto feed feature.	○
	<Configure memory> Allocates the built-in or expanded memory of the printer.	○
	<Format memory> Formats the specified area of the flash memory.	○
	<Ribbon Setting> Allows setting the fine adjustment for the ribbon motor voltages.	○
[Driver Options]		
Administration	<Import and Export> Allows importing previously saved printer driver settings and exporting the settings of this printer driver.	○
Network settings	<Network Setting> When the shared printer is installed as a network printer, the setting or status information can be shared between the server and the client.	X
Regional Options	<Language> Allows selection of the desired language to be used in the printer driver property screens.	○
	<Units> Allows the selection of the desired units of measurement.	○
	<Windows Setting> Displays the “Regional and Language Options” of Windows.	○
Printer Specifications	<Unprintable width> Specifies the unprintable area.	X
	<Model Specifications> Specifies the resolution, stock size, etc. for the printer model to be used.	X
[Logging Options]	<Logging> Allows logging printed pages and jobs debugging purposes.	○
	<Printer Code Recording> Allows recording the command data of the print jobs to files.	○
[Status Monitoring]	<Printer Status Monitoring> Allows selecting the printer status monitoring method.	○
	<Status Display Option> Allows setting the properties of the status monitor.	○

Function		Description	Support
		<Job Verification> Allows selecting the timing of status monitoring.	X
		<Communication> Allows setting the timeout and polling interval.	X
About tab	License	Shows the license information.	○
	Version	Shows the driver version, settings, and PC information. The shown information can be stored in a file.	○

Reference:

A part of the above settings can be changed in the print dialog box of the application, but such changes may only temporarily take effect.

3.1 Page Setup Tab

Clicking on the [Page Setup] tab allows you to specify the default media size, orientation and other properties of the media.

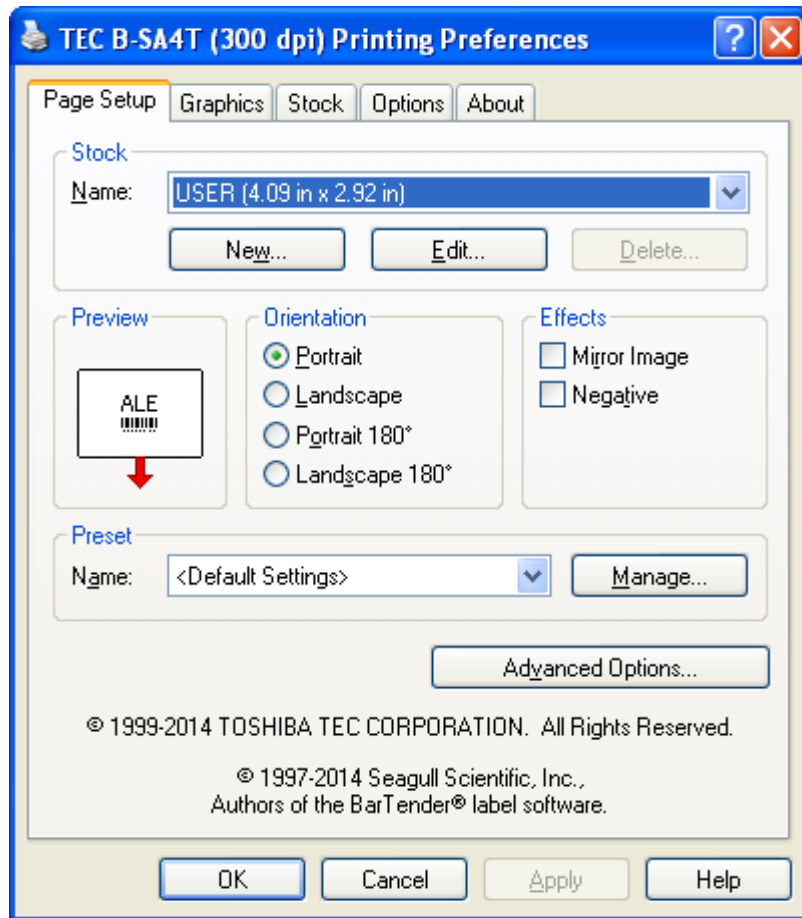

Note: When printing on the shared printer, specify the orientation and media size on the client PC from which a print job is sent. Even if the media size and the orientation are registered to the shared printer, it is not possible to share such information with the client PC.

■ Stock

• Name

Allows specifying a previously loaded stock by name to use, modify or delete.

• New, Edit, Delete

Allows adding a new label stock specification to the list, editing or deleting a label stock already on the list.

☞ **Section 3.1.1 Registering a new stock or editing the existing stock.**

The number of registerable stocks is unlimited.

■ Orientation

By clicking on "Portrait", "Landscape", "Portrait rotated 180°" or "Landscape rotated 180°", the print orientation can be changed. The preview page to the left of the orientation buttons will change to reflect the selected orientation.

Depending on the printer models, the orientation of "Portrait" may differ.

■ Effects

• Mirror Image

When this check box is selected, the print will be a mirror image.



• Negative

When this check box is selected, the print will be white on black.



Depending on the printer models, the selectable options differ.

■ Preset

Allows saving the settings of this printer driver so that they may be imported into a different or freshly installed printer driver.

☞ **Section 3.1.2 Preset**

3.1.1 Registering a new stock or editing the existing stock

By clicking either [New] or [Edit], the following screen will appear.

To register a new stock, click [New] and enter the stock name and the size.

To edit the label stock already on the list, click [Edit]. The changes will be applied to the other printer drivers' stock information.

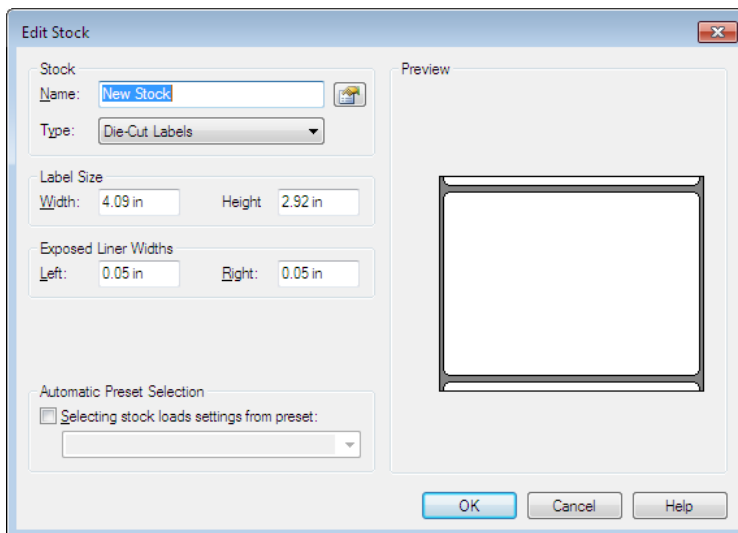

■ Stock

• Name

Displays the stock name. When a new stock is registered, any stock name can be set. (2-byte characters are acceptable.)

• Type

Select the paper type.

In case of using a Standard label, set Die-cut label or Continuous (Fixed Length) as paper type.

In case of using a Continuous paper media, set Die-cut label or Continuous (Fixed Length) or Continuous (Variable Length) as paper type.

The paper feed length will vary based on the printable data length.



Displays the advanced stock properties.

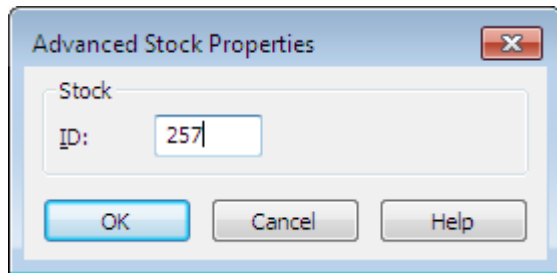

- **ID**

Displays the ID for the stock being edited. (257 to 32767)

Change the stock ID if mismatching in the stock IDs between the older printer driver and the new one causes an error. For example, when printing is performed from the application which manages stock types for Excel, Access, etc. by their stock IDs assigned by the older printer driver, a wrong stock may be selected even though the correct one has been registered.

■ Label Size

• Width, Height

Specifies the height and width of a label stock size.

■ Exposed liner width

• Left, Right

Specifies the distance between the edges of the paper backing and the edges of the label. (Set the same value for the left and right.)

Note: For the B-SP2D, B-419 and B-431 models, set both the exposed liner widths to 0 mm. Instead, set the label width to the 'effective print width + left and right exposed liner width'. Adjust the print position on the label format with the application.

■ Automatic Preset Selection

• Selecting stock loads settings from preset

Specifies whether to designate preset print settings for the selected stock.

However, this feature is unavailable and invisible unless a preset setting file has been registered. When invisible, the printer behaves in the same way when this feature is unselected.

When this check box is unchecked, printing is performed according to the current settings, regardless of the stock type.

When checked, printing is performed based on the preset settings designated for each stock type.

<Procedure>

- (1) Set the print settings, such as sensor fine adjustment and print density adjustment, for the selected stock, and save them as a preset setting file. (☞ **3.1.2 Preset.**)
- (2) Select the "Selecting stock loads settings from preset" check box and choose the created preset file from the list.
- (3) When a stock for which a preset has been designated is used, the print settings saved in such preset file are called and reflected in printing.

Note: When this feature is used under the condition more than one stock type is used in turns, designate a preset for each stock type to be used one by one.

Presets need to be created for each printer driver. Since the stock types are shared among different printer drivers, care must be taken not to designate different presets for the same stock type registered to each printer driver.

Be sure to create a preset and stock type in pairs for each printer driver.

In the case of the standard stock types, the preset settings are not succeeded with the import/export functions. Therefore, it is necessary to register the preset settings again after exporting.

3.1.2 Preset

By clicking [Manage] in the Page Setup page, the following screen display will appear to allow you to manage the printer settings with a name.

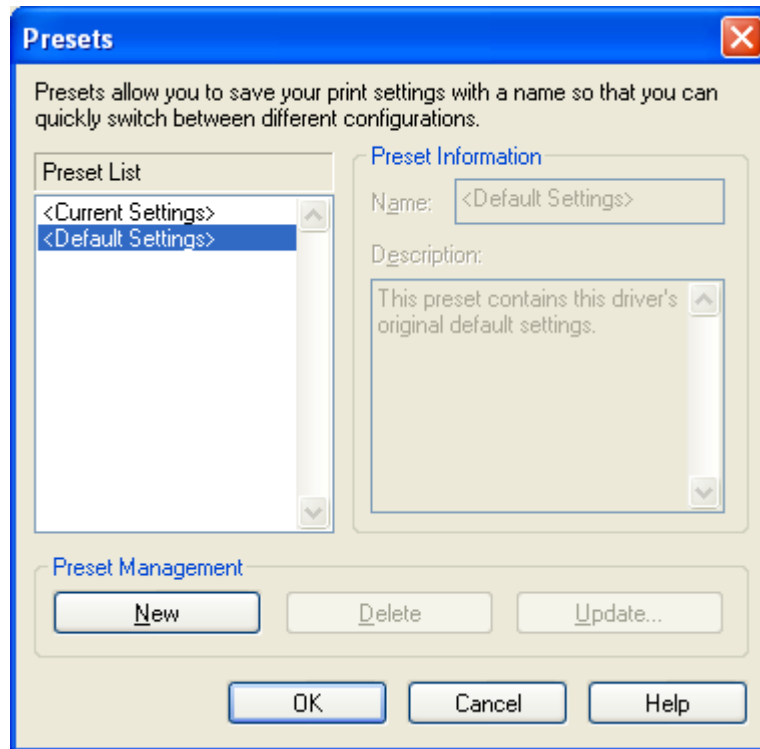

■ Preset Management

- **New**

After configuring the necessary print settings for a selected stock, click [New], name these print settings to manage them as a preset, and enter a description of these settings in the “Description” box. Click [OK] to save.

Settings saved:

[Page Setup] tab:	Label size
	Orientation
	Effects
	Advanced setting
[Graphics] tab	Dithering
[Stock] tab	Print method
	Issue mode
	Print speed
	Fine adjustment
[Option] tab	Graphic options
	Print density adjustment
	Feed adjustment
	Multiple Part Print Area Settings
	Ribbon Adjustments

- **Delete**

Clicking [Delete] enables deletion of a selected preset name. When [OK] is clicked, the changes are saved.

- **Update**

To reflect the changes in the settings of the existing preset, select the preset name and click [Update]. When [OK] is clicked, the changes are saved.

3.1.3 Advanced Options

Clicking [Advanced Options] button allows control of the printer options for which the printer driver does not provide explicit control.

■ Printing Position

◆ Position Adjustment tab

• Horizontal Offset

Enables adjustment of the print position in the horizontal direction.
Since this feature is not supported, do not change the default setting.

• Vertical offset

Enables adjustment of the print position in the vertical direction.
Since this feature is not supported, do not change the default setting.

◆ Orientation Adjustment

• Default Orientation

Enables specifying the default orientation.

0°: Bottom first

180°: Top first

Since this feature is not supported, do not change the default setting.

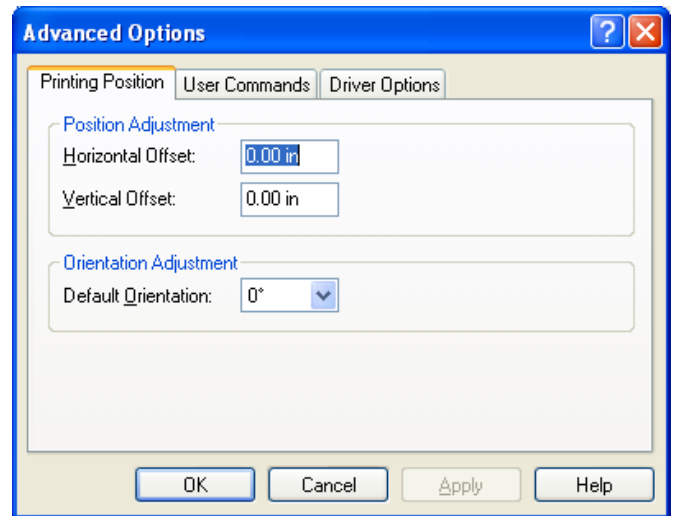

■ User Commands tab

You can program printer command strings which are to be sent to the printer at “Start of Job”, “Start of Label”, “End of Label” or “End of Job” to make up for the functions that cannot be covered by this printer driver.

Supplement: For details of the commands, refer to the External Equipment Interface Specification.

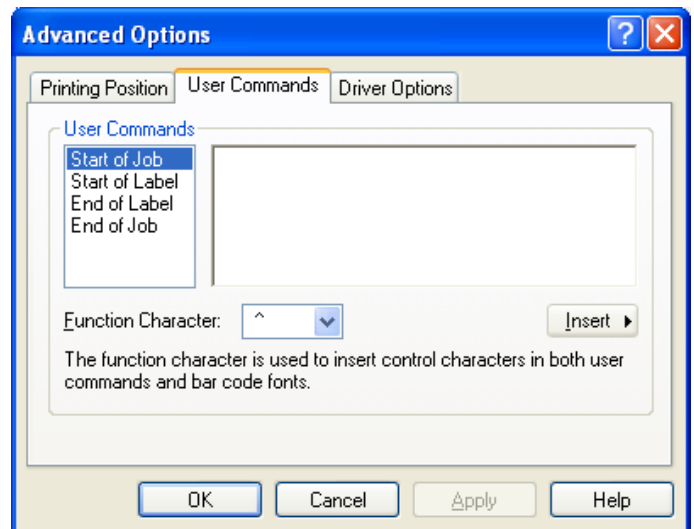

• **Function Character**

When a barcode font is used for printing, use of the function character enables encoding binary data. The default setting is a caret [^] (5EH).

The following explanation is based on an assumption that the caret [^] (5EH) is used.

Entry in hex. format

^#nn

<Example> To specify binary data of 00 to 06:

^00^01^02^03^04^05^06

Entry with abbreviation

^<ccc>

<Example> To specify binary data of 00 to 06:

^<NUL>^<SOH>^<STX>^<ETX>^<EOT>^<ENQ>^<ACK>

Entry of the function character

When using the function character as barcode data, send the function character twice.

^^

Binary data

<NUL> 00	<DLE> 10
<SOH> 01	<DC1> 11
<STX> 02	<DC2> 12
<ETX> 03	<DC3> 13
<EOT> 04	<DC4> 14
<ENQ> 05	<NAK> 15
<ACK> 06	<SYN> 16
<BEL> 07	<ETB> 17
<BS> 08	<CAN> 18
<HT> 09	 19
<LF> 0A	<SUB> 1A
<VT> 0B	<ESC> 1B
<FF> 0C	<FS> 1C
<CR> 0D	<GS> 1D
<SO> 0E	<RS> 1E
<SI> 0F	<US> 1F
	 7F

■ **Driver Option tab**

◆ **Device Line Substitution**

• **Enable Substitution**

This option allows selecting whether or not to substitute a line drawn in a print image with a Line Command.

When this check box is not checked, the line is processed as a Graphic Command.

When checked, the line is drawn using the printer's line drawing function, which may result in higher throughput.

• **Minimum Length**

The minimum length of a line that is to be recognized as a Line Command. The line shorter than this value is processed as a Graphic Command.

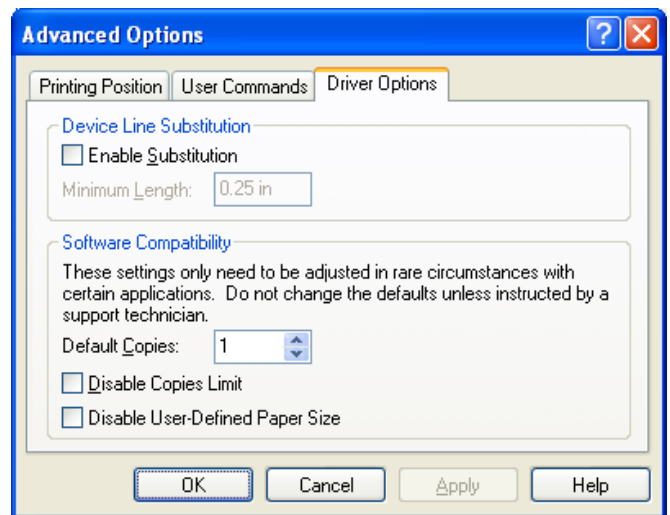

Note: Some applications do not always print correctly with this feature enabled. In such case, remove the check from the check box.

◆ **Software Compatibility**

• **Default Copies**

The number of labels to be printed as default. Unless this number is changed with the application, this value will be effective.

- **Disable Copies Limit:**

When this check box is selected, a value greater than 9999 can be set for Default Copies. Since this feature is not supported, do not change the default setting.

- **Disable User-Defined Paper Size:**

This feature disables the user-defined paper size "USER". When this check box is selected, "USER" cannot be used. Since this feature is not supported, do not change the default setting.

Not sharing the paper size.

This setting is for sharing the paper size list between each printer or not when multiple printers are added.

When it is checked, the paper size will not be shared between each printer.

- **Disable paper size sharing:**

This feature is for selecting share/not share the paper size list between each printer when multiple printers are added.

When enabled, paper size will not be shared between the printers.

3.1.4 Double-sided Printing

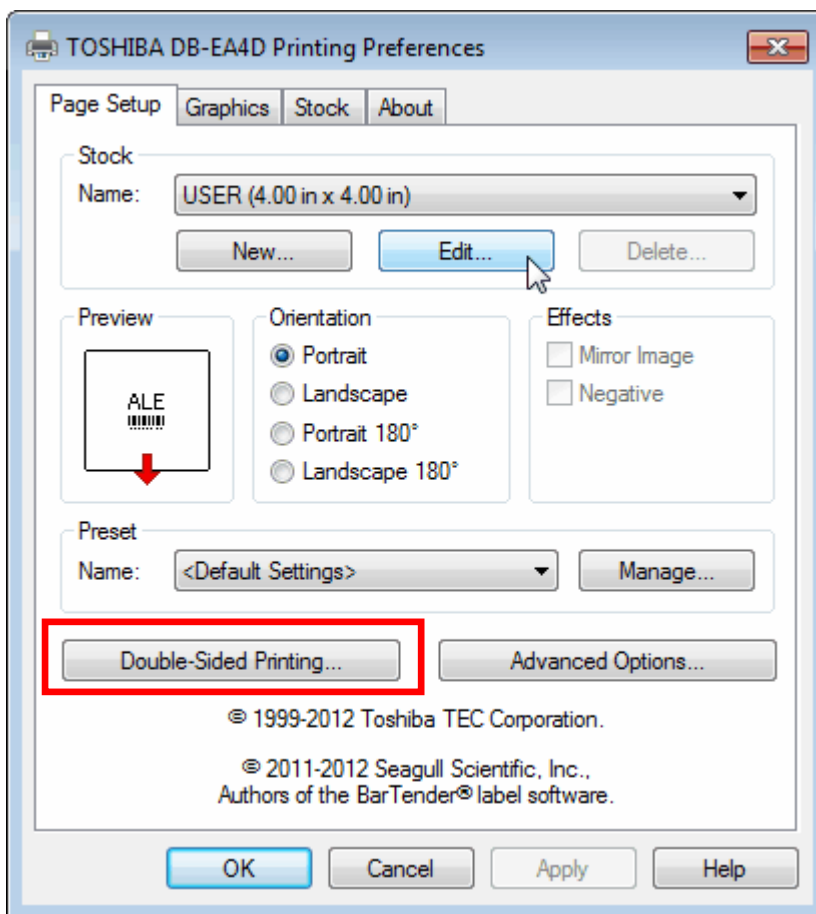

Clicking [Double-sided Printing] on the Page setup page enables double-sided print settings

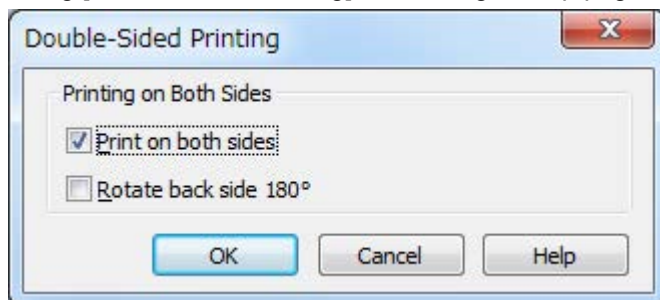









■ Printing on Both Sides

- Print on Both Sides

Select this check box enables the double-sided printing feature on the printer

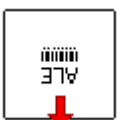
- Rotate back side 180°

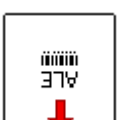
Select this check box rotates the printed output on the back side of the stock so that the top of the image comes out of the printer first.

Orientation	Rotate back side 180°	Front side	Back side
Portrait	Enable		
	Disable		
Portrait 180°	Enable		
	Disable		

3.2 Graphics Tab

Clicking the [Graphics] tab enables adjustment of dithering or color tone.

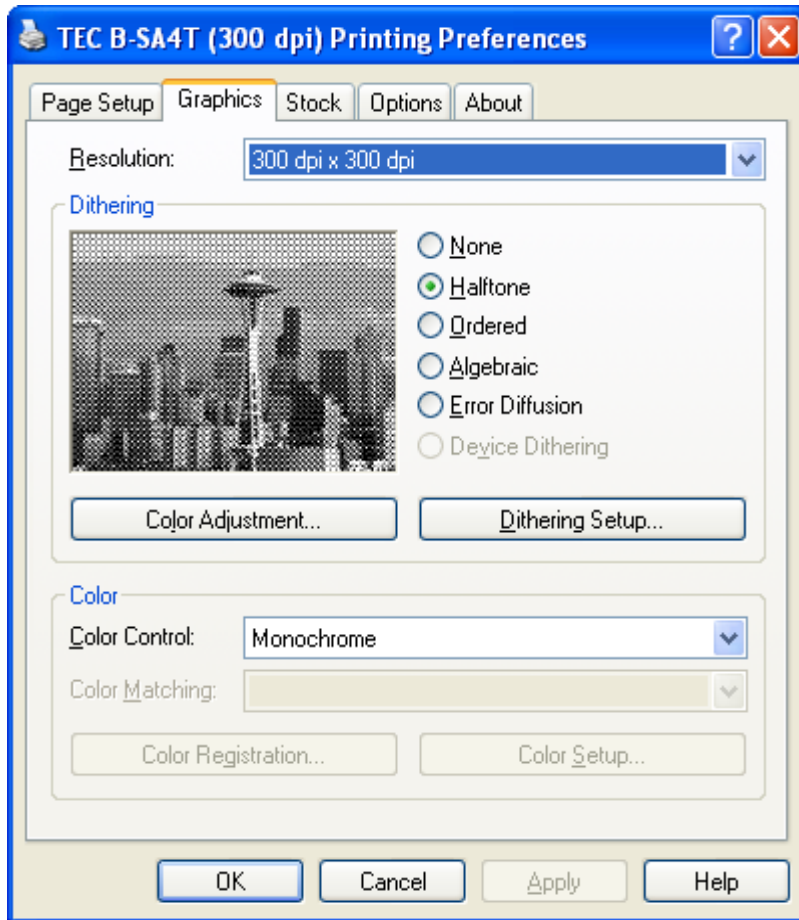

■ Resolution

Enables selecting the print head resolution. Only the resolutions supported by the printer model can be specified.

■ Dithering

Enables creating the illusion of different shades of gray by varying the pattern of dots. The more dither patterns that a device or program supports, the more shades of gray it can represent.

- None
- Halftone
- Ordered
- Algebraic
- Error Diffusion

When [Dithering Setup] is clicked, you can select an algorithm from multiple options. The algorithm differs according to the dithering patterns.

■ Color Control

Enables selecting whether to print monochrome or color.

3.3 Stock Tab

Clicking the [Stock] tab allows setting various print conditions specific to the printer, such as the media settings, issue settings, and fine adjustments.

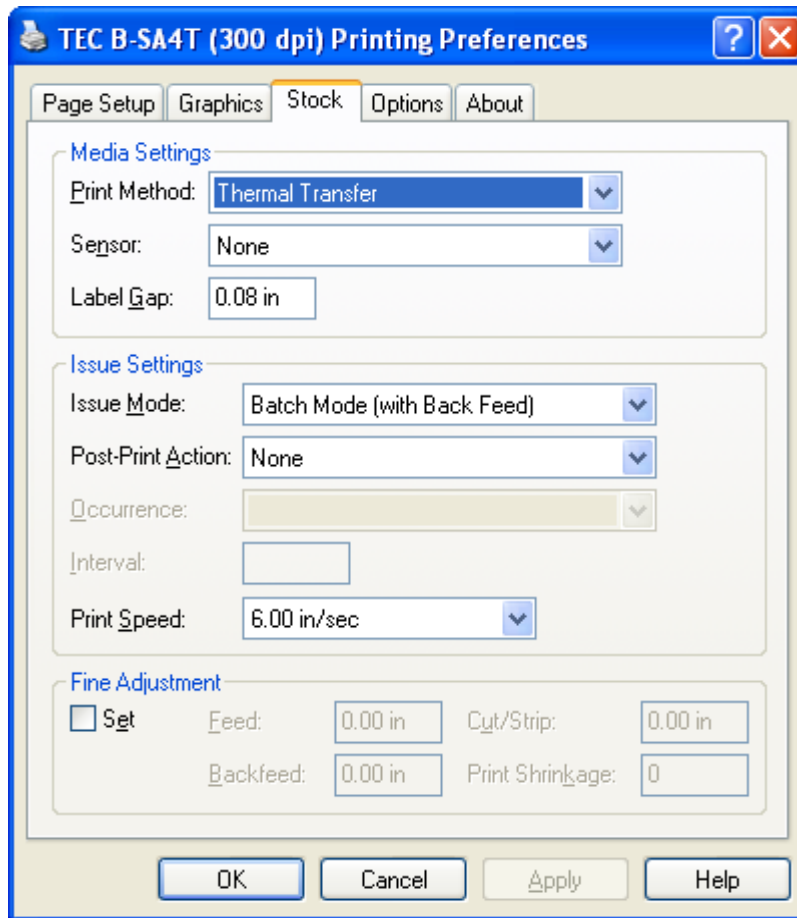

■ Media Settings

• Print Method

Enables selecting the print method.

- Direct thermal
- Direct thermal (Head up)
- Thermal transfer
- Thermal transfer (Ribbon save)

“Thermal transfer (Ribbon save)” is available only to the printer supporting the ribbon saving function.

“Direct thermal (Head up)” is available only to the RFID-enable printer. The print head is lifted to avoid RFID tag embedded area to protect the RFID tag. If you select “Direct thermal (Head up)” for non RFID-enable printer, an error occurs on the printer.

- **Sensor**

Enables selecting a sensor type.

- None
- Reflective
- Transmissive
- Transmissive (Manual Threshold)
- Reflective (Manual Threshold)
- Transmissive (Clothing Tags)
- Lower Reflective (Black mark on the reverse side)
- Lower Reflective (Manual Threshold)
- Upper Reflective (Black mark on the print side)
- Lower Reflective (Punch hole)

Select “Transmissive (Preprinted Labels)” or “Reflective (Manual Threshold)” when the threshold has been set through the key operation in the printer system mode.

“Transmissive (Clothing Tags)” is available for B-431 only.

“Lower Reflective (Black mark on the reverse side)”, “Lower Reflective (Manual Threshold)”, “Upper Reflective (Black mark on the print side)” and “Lower Reflective (Punch hole)” are selectable for B-852 or B-852R.

- **Label Gap**

Enables setting the inter-label gap size. In the case of tag paper, enter the non-printable area size.

■ Issue Settings

- **Issue Mode**

- Batch Mode (with Back Feed)
- Strip Mode (with Back feed)
- Strip Mode (when using the applicator)
- Partial Cut (without Back Feed)
- Batch Mode
- Cut Mode

When the cutter unit is installed on the printer to perform the cut issue, select “Batch Mode (with Back Feed)” or “Cut Mode”.

When the strip module is installed on the printer to perform the strip issue, select “Strip Mode (with Back Feed)” or “Strip Mode (when using the applicator)”.

When “Partial Cut (without Back Feed)” is selected, this option will be always specified.

- **Post-Print Action**

Enables selecting whether the cut operation is performed or not.

- None
- Cut
- Partial Cut
- Partial Cut and Pause
- Cut and Pause
- Pause
- Linerless Cut
- Linerless Cut and Pause

When “Partial Cut” is selected, “Partial Cut (without Back Feed)” will be always set for the Issue Mode. When “Linerless Cut” is selected, “Batch Mode (with Back Feed)” will be always set for the Issue Mode.

“Partial Cut and Pause”, “Cut and Pause”, “Pause” and “Linerless Cut and Pause” are not supported at present.

• Occurrence

Enables specifying how often labels should be cut. If “Strip Mode (with Back Feed)” is selected for the Issue Mode, this feature is disabled.

- After every page -----Cuts labels after each label is finished printing.
- After specified interval -----Cuts labels after the number of labels specified in the Interval setting.
- After specified interval (Per Page)-----Cuts labels after the number of labels specified in the interval setting and at the end of the identical copy.
- After identical copies -----Cuts after the identical copy is finished printing.
- After job -----Cuts labels only after the entire print job is finished printing.
- After specified interval-----If the special printer control (partial cut, etc.) is required, cuts labels after (depending on printers) the number of labels specified in the Interval setting.

Example: 4 pages are issued by 5 copies each

	Cut Interval	▲: Cut operation
Every page	---	1▲1▲1▲1▲1▲2▲2▲2▲2▲2▲3▲3▲3▲3▲3▲4▲4▲4▲4▲4▲
Specified interval	3	1 1 1▲1 1 2▲2 2 2▲2 3 3▲3 3 3▲4 4 4▲4 4▲
Specified interval (Per page)	3	1 1 1▲1 1 2 2 2▲2 2 2▲3 3 3▲3 3 4 4 4▲4 4▲
Identical copies	---	1 1 1 1 1▲2 2 2 2 2▲3 3 3 3 3▲4 4 4 4 4▲
After job	---	1 1 1 1 1 2 2 2 2 2 3 3 3 3 3 4 4 4 4 4▲
Specified interval (depending on the printers)	3	1 1 1▲1 1 2 2 2▲2 2 2▲3 3 3▲3 3 4 4 4▲4 4▲

• Interval

Enables specifying the cut interval.

• Print Speed

Enables specifying the print speed. Selectable speed differs according to the printer models.

■ Fine Adjustment

• Set

When the “Set” check box is selected, you can set fine adjustment values. When the “Set” check box is not selected, the adjustments are grayed out and the printer operates according to its current settings.

Adjustable settings differ depending on the printer models.

- Feed
- Backfeed
- Cut/Strip
- Print Shrinkage

• Feed

Specifies the length of label stock that will feed after printing.

• Backfeed

Specifies the length of label stock that is retracted before printing.

• Cut/Strip

In the case of the cut issue, this specifies the length of label to feed before cutting the label. In the case of the strip issue, the length of label to feed before peeling the label is specified.

• Print Shrinkage

Used to compensate for label print shrinkage or expansion.

3.3.1 DB-EA4D Stock Tab

Clicking on [Double-sided Printing] on the Page setup page enables double-sided print settings.

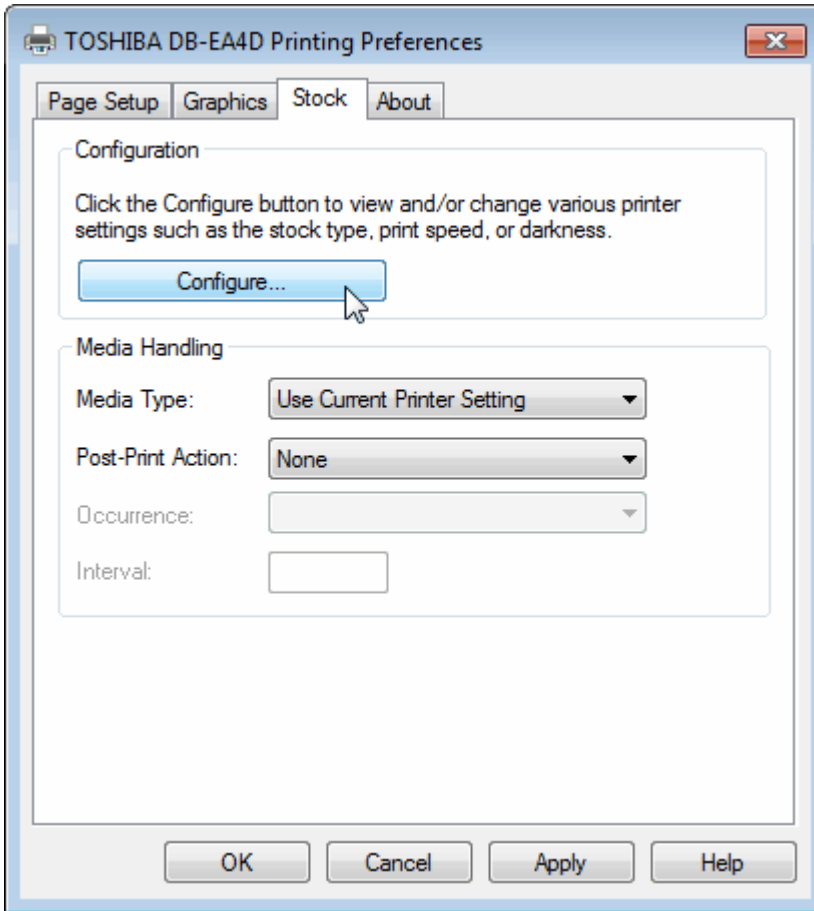

■ Configuration

- Configure

Click "Configure...", the below window will be shown during communicating with printer.

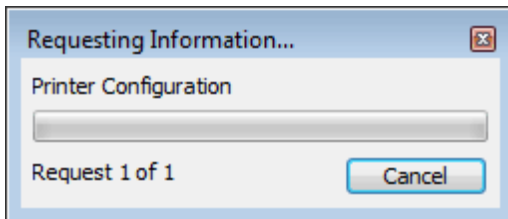

3.3.1.1 Printer Configuration

◆ Media

The "Printer Configuration" screen appears and the current settings can be found in "Media Settings" as shown below.

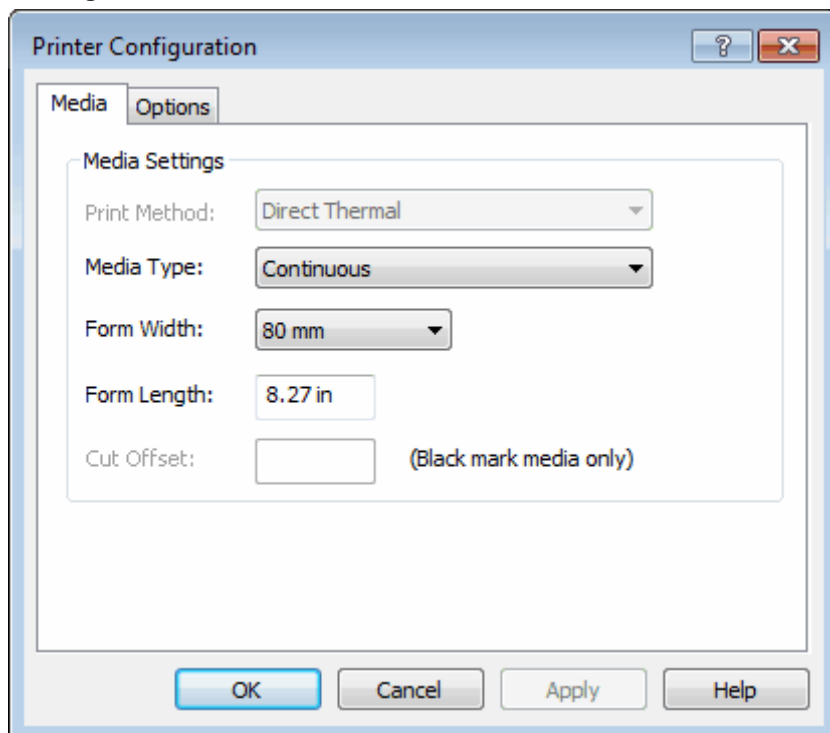

In order to change its configurations, follow the operations below.

● Print Method

This setting cannot be changed.

● Media Type

5 options are available for "Media Type".

- Continuous
- Labels With Gaps
- Labels With Black Marks
- Labels With Perforation
- Cut Sheet

● Form Width

4 options are available for "Form Width".

- 58 mm
- 80 mm
- 4 in
- 5.1 in

● Form Length

About "Form Length", you can input in the text box.

● Cut Offset

If you select "Labels With Black marks" for "Media Type", you can define "Cut Offset" which is the distance between black mark and the cut position.

◆ Option

Select the [Options] tab to see the current configuration of "Print Speed" and "Darkness" as shown below.

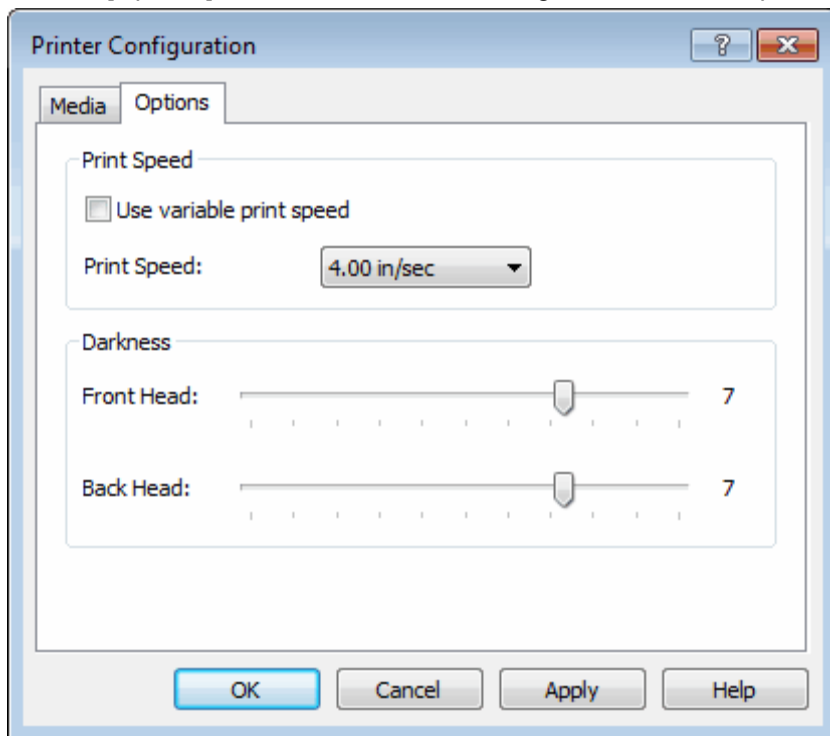

• Print Speed

In case "Variable Print Speed" is disabled, "Print Speed" is available from 3.00in/sec to 6.00in/sec

In case "Variable Print Speed" is enabled, printer will automatically adjust its printing speed. But you can specify printer's "Maximum Print Speed" from 3.00in/sec to 6.00in/sec.

• Darkness

About "Darkness" option, move the slider to left/right to change its configuration.

■ Media Handling

• Media Type

Select the media type.

- Use Current Printer Setting (Default)
- Continuous
- Labels With Gaps
- Labels With Black Marks
- Labels With Perforation
- Cut Sheet

• Post-Print Action

Enables selecting whether the cut operation is performed or not.

- None
- Cut

• Occurrence

Enables specifying how often labels should be cut.

- After every page -----Cuts labels after each label is finished printing.
- After specified interval -----Cuts labels after the number of labels specified in the Interval setting.
- After specified interval (Per Page)-----Cuts labels after the number of labels specified in the interval setting and at the end of the identical copy.
- After identical copies -----Cuts after the identical copy is finished printing.
- After job -----Cuts labels only after the entire print job is finished printing.

Example: 4 pages are issued by 5 copies each

Single-sided printing

	Cut Interval	▲: Cut operation
Every page	---	1▲1▲1▲1▲1▲2▲2▲2▲2▲2▲3▲3▲3▲3▲3▲4▲4▲4▲4▲4▲
Specified interval	3	1 1 1▲1 1 2▲2 2 2▲2 3 3▲3 3 3▲4 4 4▲4 4▲
Specified interval (Per page)	3	1 1 1▲1 1▲2 2 2▲2 2▲3 3 3▲3 3▲4 4 4▲4 4▲
Identical copies	---	1 1 1 1 1▲2 2 2 2 2▲3 3 3 3 3▲4 4 4 4 4▲
After job	---	1 1 1 1 1 2 2 2 2 2 3 3 3 3 3 4 4 4 4 4▲

Double-sided printing, (Front / Back)

	Cut Interval	▲: Cut operation
Every page	---	1/2▲1/2▲1/2▲1/2▲1/2▲3/4▲3/4▲3/4▲3/4▲3/4▲
Specified interval	3	1/2 1/2 1/2▲1/2 1/2 3/4▲3/4 3/4 3/4▲3/4▲
Specified interval (Per page)	3	1/2 1/2 1/2▲1/2 1/2▲3/4 3/4 3/4 3/4▲3/4▲
Identical copies	---	1/2 1/2 1/2 1/2 1/2▲3/4 3/4 3/4 3/4 3/4▲
After job	---	1/2 1/2 1/2 1/2 1/2 3/4 3/4 3/4 3/4 3/4▲

• Interval

Enables specifying the cut interval.

3.4 Options Tab

Models other than B-EP2DL-G, B-EP4DL-G, B-FP3D and B-FP2D

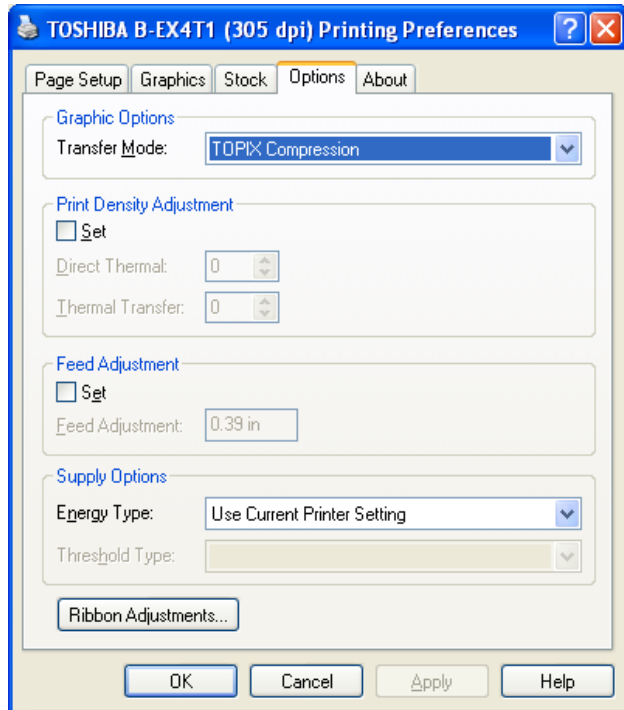

B-EP2DL-G, B-EP4DL-G, B-FP3D and B-FP2D

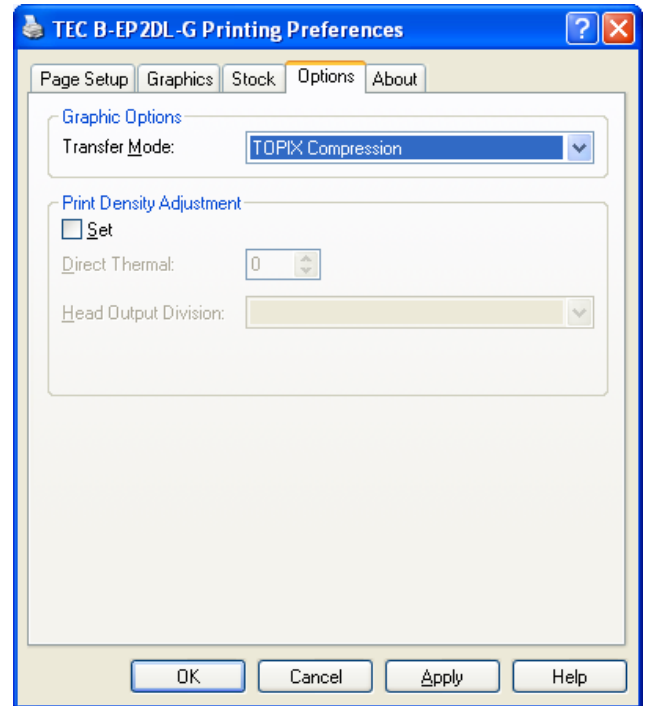

■ Graphic Options

• Transfer Mode

Allows selecting the method used to download graphics to the printer. Basically, select the “TOPIX compression” mode.

The “TOPIX compression (XOR)” method improves the throughput by processing only a different part from the previous page. Choose this option when you print a fixed format partly including variable data.

However, the throughput may not improve depending on the image to be printed.

■ Print Density Adjustment

When the “Set” check box is selected, you can set the print density (print head voltage) for each of Direct thermal and Thermal transfer.

When the “Set” check box is not selected, the printer operates according to its current setting.

For B-EP2DL-G, B-EP4DL-G, B-FP3D and B-FP2D, the “Head Output Division” feature is provided, which enables properly changing the print quality and print speed depending on the selected print head control.

When the “Set” check box is not selected, the printer operates according to its current setting.

■ Feed Adjustment

When the “Set” check box is selected, you can set the length of the label the printer automatically feeds after printing. Before printing the next label, the printer will automatically feed the label in the reverse direction to the print start position.

When not checked, the printer operates according to its current setting.

This feature is not available to B-EP2DL-G, B-EP4DL-G, B-FP3D and B-FP2D.

■ Supply Options

Allows setting the printing energy for each of “Direct thermal” and “Thermal transfer”. When “Use Current Print Setting” is selected, the printer operates according to the currently selected setting. Selection of “Direct thermal” or “Thermal transfer” depends on which is selected for “Print Method” on the Stock page.

■ Ribbon Adjustments

When the thermal transfer method is selected, setting the conditions related to the ribbon is allowed. (☞ 3.4.2 Ribbon Adjustments.)

■ Multiple Part Print Area Settings

Enables setting the duplicate print area on double-layer thermal paper. This feature is available only to B-419 and B-EV4 (203 dpi). For B-EV4 (203 dpi), “Variable Speed A” or “Variable Speed B” specified for the “Print Speed” on the Stock page is reflected in the printer behavior.

3.4.1 Multiple Part Print Area Settings (B-EV4 (203 dpi) only)

Clicking “Multiple Part Print Area Settings” on the Options page enables setting the duplicate print area properties for the double-layer thermal paper.

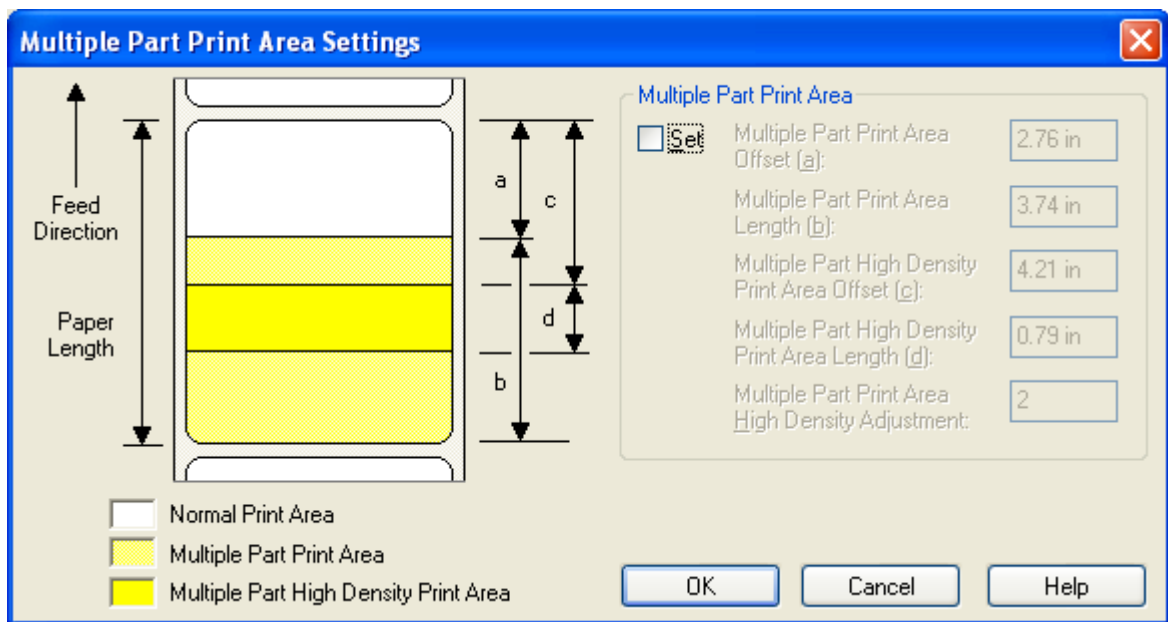

■ Multiple Part Print Area

When the “Set” check box is selected, you can specify the details of “Multiple Part Print Area”. “Multiple Part Print Area” is the area where the printer prints both sheets of the double-layered thermal paper at the same time by applying the higher print energy. When the “Set” check box is not selected, the printer operates according to its current settings.

• Multiple Part Print Area

Enables setting “Multiple Part Print Area Offset (a)” (X-coordinate of the multiple part print area start position) and “Multiple Part Print Area Length (b)”. The print on the specified area will become darker than the normal print areas.

- Multiple Part Print Area Offset: 0.0 mm to 390.0 mm
- Multiple Part Print Area Length: 0.0 mm to 390.0 mm

• **Multiple Part High Density Print Area**

Enables setting “Multiple Part High Density Print Area Offset (c)” (X-coordinate of the multiple part high density print area start position) and “Multiple Part High Density Print Area Length (d)”.

This area is to be printed with much higher print energy than the multiple part print area to enable clearly printing small or fine characters and barcodes on the second sheet. The extra energy level can be specified by entering a value in “Multiple Part Area High Density Adjustment”. (If “Multiple Part Area High Density Adjustment” is set to “0”, which means no difference, and both areas are printed with the same print density.)

- Multiple Part High density Print Area Offset: 0.0 mm to 390.0 mm
- Multiple Part High density Print Area Length: 0.0 mm to 390.0 mm

• **Multiple Part Print Area High Density Adjustment**

Enables specifying how much extra energy is applied for “Multi Part Print High Density Area” than the “Multiple Part Print Area”.

- Multiple Part Print Area High Density Adjustment: 0 to 10

Supplement:

1. Duplicate printing is available only to double-layer thermal paper. Triple- or more layer paper is not accepted.
2. If the print on the second sheet is too light, specifying this print area as “Multiple Part High Density Print Area”. Doing this improves the print result.
3. It is possible to specify “Multiple Part Print Area” and “Multiple Part High Density Print Area” independently.
4. It is not necessary to specify both “Multiple Part Print Area” and “Multiple Part High Density Print Area”.
5. “Multiple Part High Density Print Area” is not necessarily within “Multiple Part Print Area”.
6. The Print Density Adjustment value, set in the Options page, is reflected in “Multiple Part Print Area” and “Multiple Part High Density Print Area”.

• Print density of normal print area =

• Print density for “Multiple Part Print Area” = +

• Print density for “Multiple Part High Density Print Area” = + +

: Print density adjustment value

: Standard print density for “Multiple Part Print Area”

: Fine adjustment value for “Multiple Part High Density Print Area”

3.4.2 Ribbon Adjustments

Clicking [Ribbon Adjustments] on the Options page enables ribbon settings.

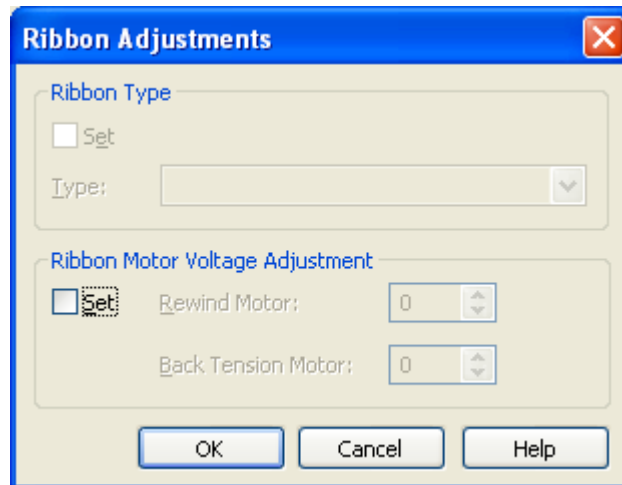

■ Ribbon Type

When the “Set” check box is selected, configurations related to the ribbon is allowed. When the “Set” check box is not selected, the printer operates according to the currently selected settings. This menu is provided only to the models for which a ribbon type is selectable.

• Type

Enables selecting a ribbon type used on the printer. Selectable ribbon types are different depending on the printer model.

■ Ribbon Motor Voltage Adjustment

When the “Set” check box is selected, the ribbon motor voltage can be adjusted for preventing ribbon wrinkles. When the “Set” check box is not selected, the printer operates according to the currently selected settings.

• Rewind Motor

The rewind motor which drives the ribbon take-up core takes up the used ribbon. When the value is reduced, the rewind motor torque turns down, causing a decrease in the ribbon tension. The setting value range varies depending on the printer model.

• Back Tension Motor

The back tension motor which drives the ribbon feed core pulls the ribbon backward to maintain the ribbon tension. When the value is reduced, the back tension motor torque turns down, causing a decrease in the ribbon tension. The setting value range varies depending on the printer model.

3.5 Fonts Tab

Clicking [Fonts] tab of the Properties screen enables adding, deleting, modifying, importing, exporting and viewing currently defined barcode fonts. These fonts will be listed in many Windows applications that normally do not support printing barcodes. Although they will not appear as barcodes on the screen, they will print as barcodes. An unlimited number of bar fonts can be created, each of which may have different barcode parameters.

Notes:

- Barcode fonts need to be registered to each printer driver.
In the case you print on a shared printer, register barcode fonts to both the client PC and the printer server PC. It is not possible to share the barcode fonts between the client PC and the printer server PC.
The Import and Export features are useful to easily register the barcode font list to other printer drivers. Refer to **Driver Options**.
- To use Kanji as barcode font, click the [Tools] tab, [Configure], select "Printer Options" and set "ESC/LF/NUL" for the Control Codes.
- Chinese Gothic and Chinese Serif are not supported in B-EX4T3 (600 dpi).

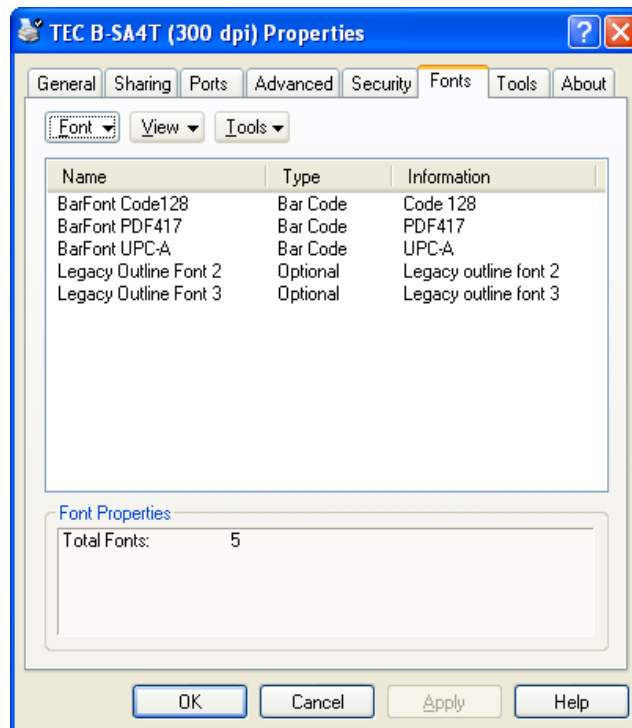

■ Font

Enables adding, deleting and editing the barcode fonts.



• New Bar Code Font

Enables adding a new barcode font to the list. There is no limit for the number of barcode fonts to be registered.

☞ Refer to **Section 3.5.1 Bar code Font**.

• Edit

Enables modifying the currently selected barcode font.

Select a barcode font and open the "Bar Code Font" screen by clicking [Font] and "Edit" or right-clicking the font and selecting "Edit".

- **Delete**

Enables deleting the currently selected barcode font.

Select a barcode font, then click [Font] and “Delete” or right-click the font and select “Delete”.

- **View**

Enables filtering the barcode font types to display. “Resident Fonts” and “Bar Code fonts” are available.



Supplement: The barcode font list on the [Fonts] page only shows the font types usable by the applicable printer driver. Barcode fonts registered to other printer driver installed in the same PC are not displayed.

- **Tools**

Enables setting the resident fonts and the printer driver options.

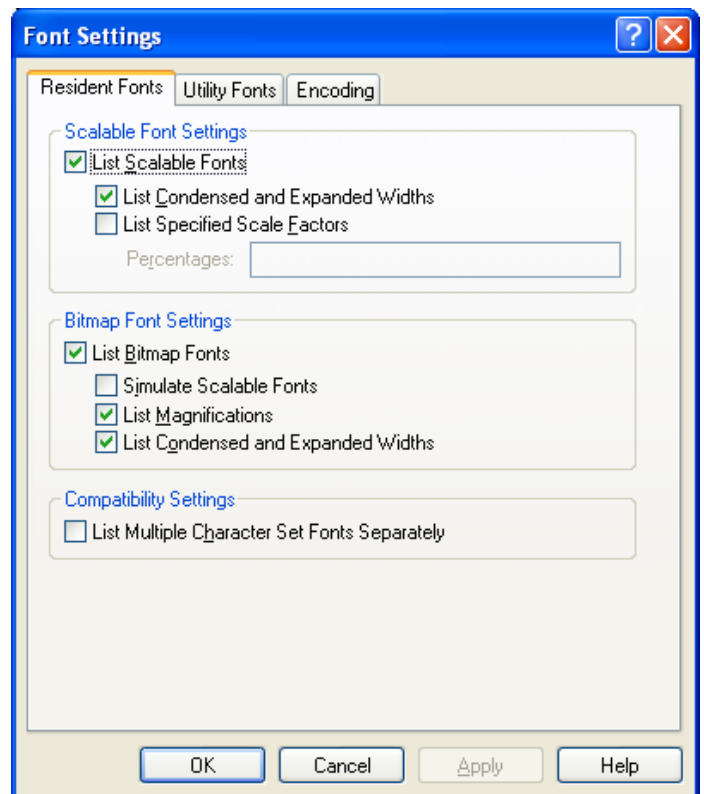

- ◆ **Resident Fonts tab**

- **Scalable Font Settings**

List Scalable Fonts: When this check box is selected, the scalable fonts (outline fonts) can be used on the application. When this is not selected, the scalable fonts cannot be used.

List Condensed and Expanded Widths: When this check box is selected, scalable fonts (outline fonts) with the width condensed or expanded can be used.

List Specified Scale Factors: When this check box is selected, the scalable fonts (outline fonts) with the width reduced or enlarged at an optional scale factor can be used. Since this feature is not supported, do not change the default setting.

Percentages: Selecting the “List Specified Scale Factors” check box enables specifying a scale factor. Since this feature is not supported, do not change the default setting.

- **Bitmap Font Settings**

List Bitmap Fonts: When this check box is selected, the bitmap fonts can be used on the application. When this is not selected, the bitmap fonts cannot be used.

Simulate Scalable Fonts: When this check box is selected, the size of bitmap fonts can be specified to the same size of outline fonts. Since this feature is not supported, do not change the default setting.

List Magnifications: When this check box is selected, magnified bitmap fonts can be used.

List Condensed and Expanded Widths: When this check box is selected, bitmap fonts with the width condensed or expanded can be used.

- **Compatibility Settings**

List Multiple Character Set Fonts Separately: When this check box is selected, printer font data can be printed with another code page.

- ◆ **Utility Fonts tab**

Supplement: Utility font do not correspond to actual text fonts on the printer, but are used to control advanced printer features, such as barcodes, RFID and sending direct commands to the printer.

- **Utility Font Settings**

List Utility Fonts: When this check box is selected, the utility fonts can be used on the application. When this is not selected, the utility fonts cannot be used.

List Bar Code and RFID Fonts: When this check box is selected, barcode fonts and RFID fonts can be used. However, the RFID fonts is not supported.

List Printer Command Font: When this check box is selected, specified data can be sent to the printer as it is.

List Driver Command Font: When this check box is selected, the font used to generate commands from data in the specified format can be used. Since this feature is not supported, do not change the default setting.

- **Compatibility Settings**

Combine Adjacent Bar Code & RFID Fields: When this check box is selected, it is possible to prevent one barcode font from being separated into two or more barcodes when using a specific application such as MS Word and PowerPoint.

If data beginning or ending with a space is printed in a barcode font, such a space is deleted from the data. Also, when the same barcode font and the same Y position are specified for different data, they are all connected.

This feature is enabled as default. When unnecessary, you may disable it.

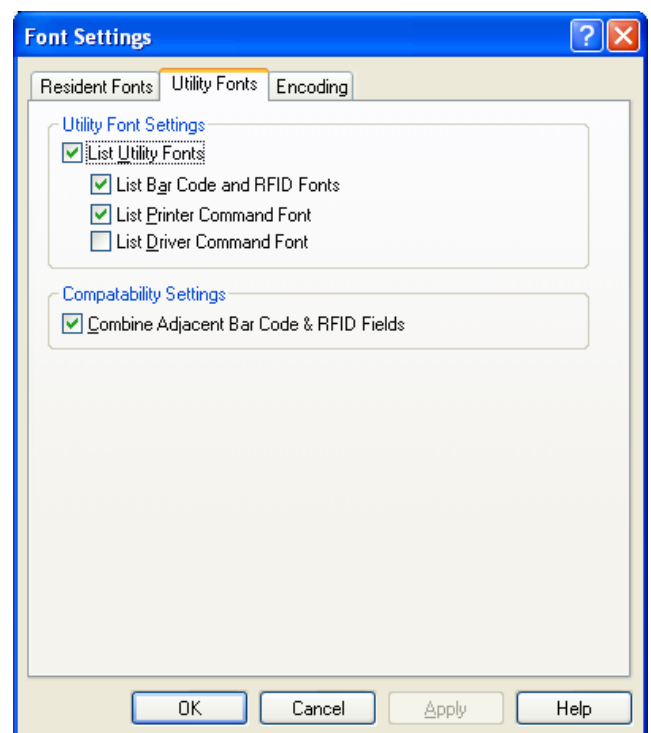

◆ Encoding tab

• Text Encodings

Enables setting the code page for the data to be printed in the resident fonts. Wrong code page setting causes the printer not to print properly. Since this feature is not supported, do not change the default setting.

In the case the code page of B-850, B-852, or Arabic is selected for the printer, the data is printed as it looks with the printer font. But unsupported characters are not processed as the printer font. For the code page other than B-850, B-852 and Arabic, some characters may not be printed as they look or processed as the printer font.

Only the characters in the code page provided in the External Equipment Interface Specification of each printer model are usable.

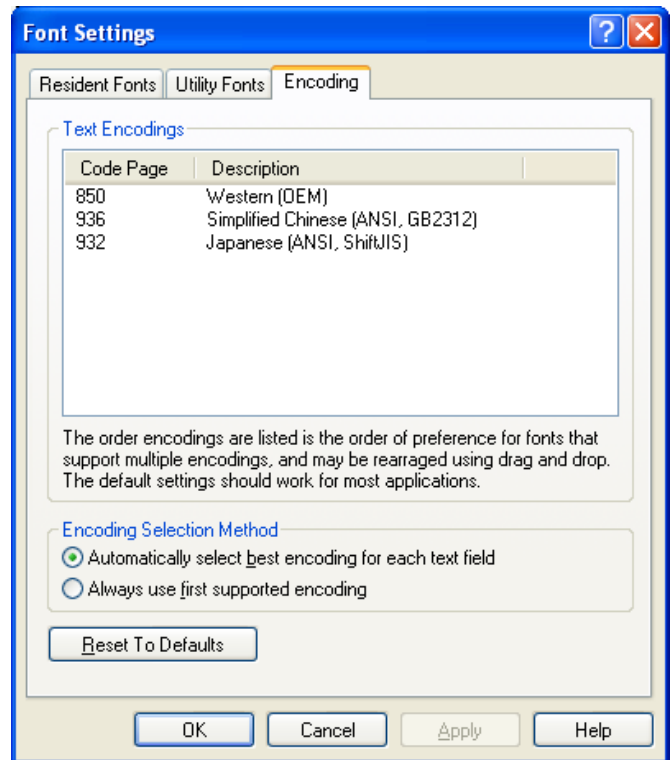

3.5.1 Bar Code Font

When clicking [Font] in the [Fonts] page and selecting “New Bar Code Font”, the following screen appears to enable addition of a new barcode font.

Also, you can modify the registered barcode font properties. First select the barcode font to edit, then click [Font] in the [Fonts] page and select “Edit” or right-click the barcode font and select “Edit” to open the Bar Code Font screen.

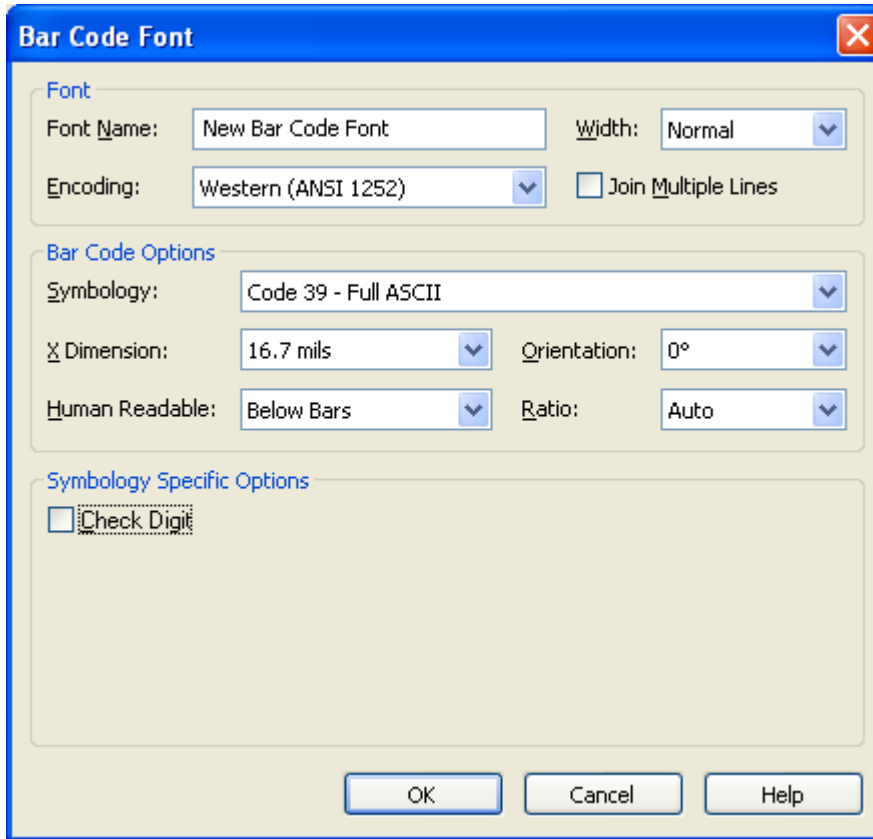

■ Font

- **Font Name**

Enables entering a barcode font name using alphanumeric characters, Kanji or Kana.

- **Encoding**

Enables specifying the code page for encoding characters. In the case 2-byte characters like Kanji are used, specify “Japanese”.

- **Join Multiple Lines**

When this check box is selected, multiple-line data specifying the same barcode font is combined into a single barcode. This allows paragraph text to be encoded into one barcode. When this setting is not enabled, each row of text will generate a separate barcode.

Supplement: All texts specifying the same barcode font in a page are combined and printed as one barcode.

- **Width**

Enables specifying the width of the text data, to be encoded into a barcode, on the application screen.

Supplement: This feature is useful when the text data does not fit in a page. Depending on the applications; however, this feature may not work. In that case, or when encoding a large number of texts in a single barcode, enable “Join Multiple Lines”.

■ Bar Code Options

• Symbology

Enables selecting a type of the barcode or two dimensional code from the following.

- Code 39 - Full ASCII
- Code 39 - Regular
- Code 93
- Code 128
- Codabar (NW-7)
- Data Matrix
- EAN/JAN-8
- EAN/JAN-13
- GS-1 Composite
- GS-1 DataBar (RSS)
- Interleaved 2-of-5(ITF)
- Japanese 4-State Customer Code
- KIX 4-State Customer Code
- MaxiCode
- MicroPDF417
- Micro QR Code
- MSI Plessey
- PDF417
- QR Code
- Royal Mail 4-State Customer Code
- UPC-A
- UPC-E
- US POSTNET (Zip, Zip+4, & DPBC)
- USPS Intelligent Mail (4State-Customer-Code)

• X Dimension

Enables specifying the width of a narrow bar or a cell. (It differs depending on the printer models or selected barcode symbologies.)

Supplement: The height of a barcode is adjustable by specifying the font size on the application.

• Human Readable

Enables specifying the visibility of the human readable characters displayed with the barcodes on the labels. (Depending on the barcode symbologies, this feature may not be available.)

- None
- Below Bars

• Orientation

Enables specifying the orientation of the barcode on the label.

- 0°
- 90°
- 180°
- 270°

• Ratio

Enables specifying the wide-to-narrow element ratio of the barcode. (Depending on the barcode symbologies, this feature may not be available.)

- Auto
- 2.0 to 3.0

■ Symbology Specific Options

Enables setting options specific to the selected barcode symbology.

3.6 Tools Tab

Clicking the [Tools] tab enables testing the printer operations or setting variable options.

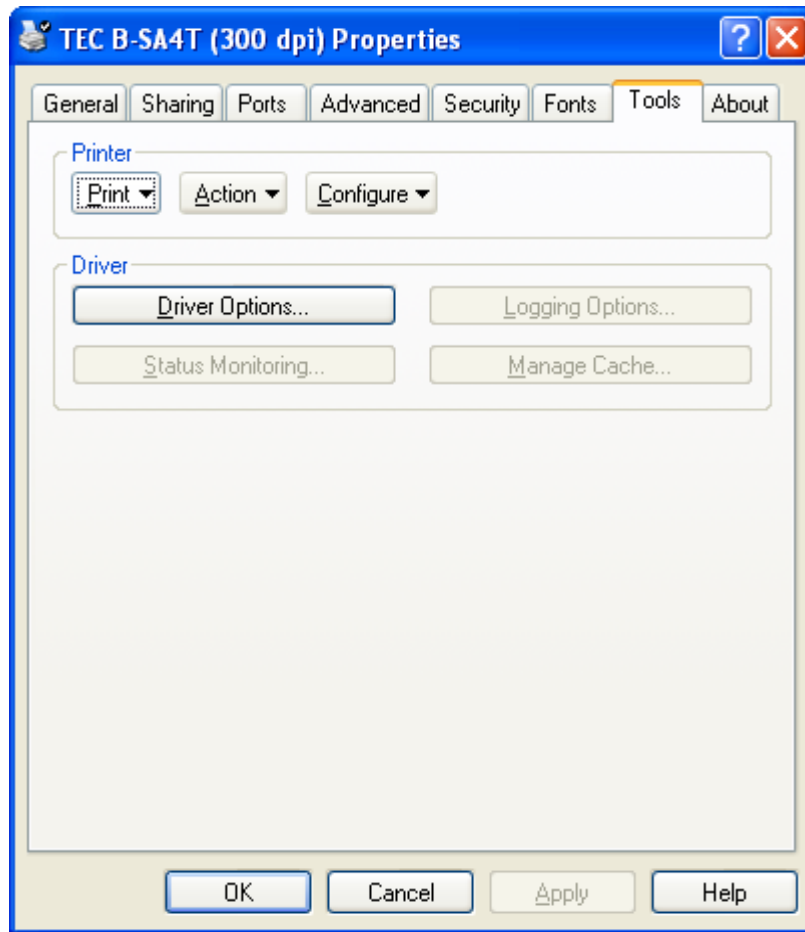

■ Printer

◆ Print



- **Generic test**

Prints an image “TEST” on a label on the print conditions (Media size, position adjustment, sensor type, etc.) specified in Stock page. This should help verify that the computer being used is communicating with the printer.

- **Blank page**

Prints a blank label on the specified conditions (Media size, position adjustment, sensor type, etc.)

◆ Action

Available features differ depending on the printer models.

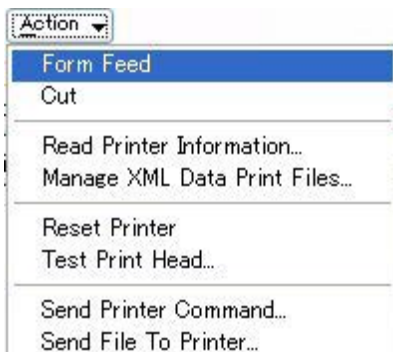

- **Form Feed**

Feeds a label on the specified conditions Media size, position adjustment, sensor type, etc.)

- **Cut**

Cuts the label immediately.

- **Read Printer Information**

Displays the version and option information obtained from the printer. The information to be obtained differs depending on the printer models and interfaces. This feature is not supported.

- **Manage XML Data Print Files**

Enables managing the format, graphic and font files related to the XML data in the printer. This feature is not supported

- **Reset Printer**

Enables resetting the printer. This is available only when the RS-232C interface is used.

- **Test Print Head**

Allows execution of the printer's broken pins test. The test will detect if thermal elements in the print head are open. A failed test would suggest a need to replace the print head to ensure perfect print quality. Clicking this menu will bring up the display window on the right.

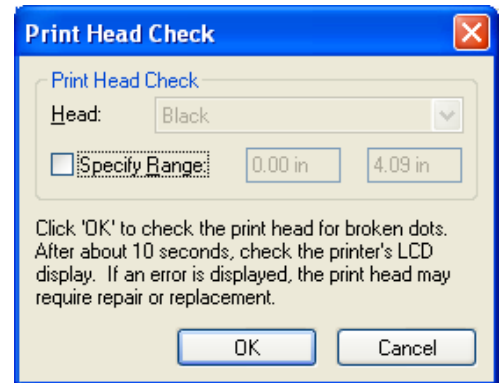

- **Send Printer Command**

Allows sending the programmed printer commands to the printer. Clicking [Query] enables displaying the printer status returned in response to the printer command. The Query feature is available only when the bidirectional communication is enabled and the query commands are sent to the printer.

For details of the printer commands, refer to the *External Equipment Interface Specification* of each printer model.

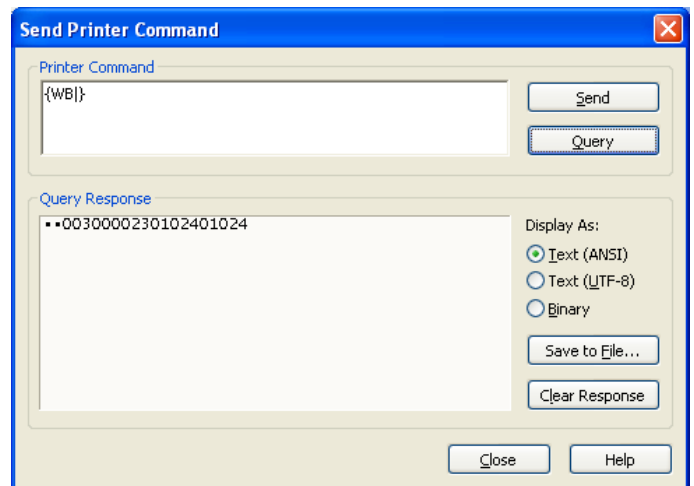

- **Send File To Printer**

Allows sending a command file directly to the printer.

◆ Configure



- **Printer Options**

Automatic Status Response: When this check box is selected, the printer will automatically send the status to the host at the end of print or occurrence of an error.

Note: The printer driver does not use its status. When this is not necessary, remove the check.

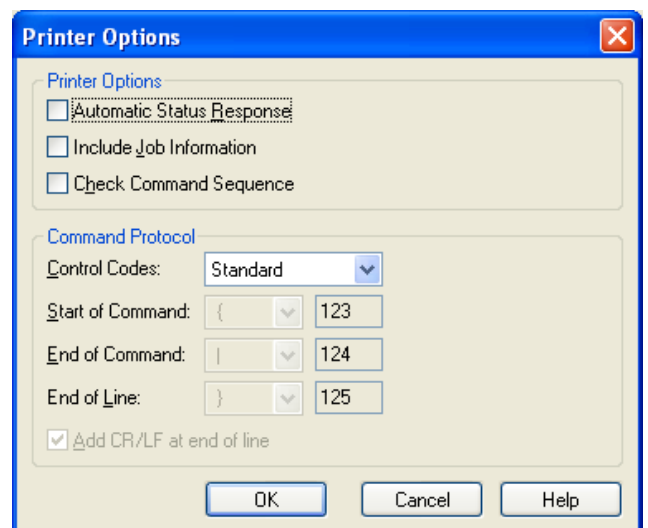

Include Job Information: When this check box is selected, the job information obtained from the printer through the SNMP feature is added to those to be printed. This information is displayed on the Network Tool.

Note: This feature is disabled as default. If you do not need the job information on the SNMP, do not change the default setting.

Check Command Sequence: When this check box is selected, a command, which checks whether any necessary command is missing from a command string the printer received, is attached. This function is available only to B-EV4-T and B-EV4-G.

• Command Protocol

Control Codes: Enables setting the control code for the printer commands. It must be the same as the control code specified on the printer.

Note: By default, "Standard" is specified. When the Kanji code is specified for the printer font, PEF417, MicroPDF417, Data Matrix, MaxiCode or QR code, set "Control Codes" to "ESC/LF/NUL". Failure to do so causes an error.

• Bluetooth Connection

In the case of Bluetooth connection using the virtual COM port, enable the checkbox.

• Delay Close

Sets the wait time before link disconnected from the data submitted.

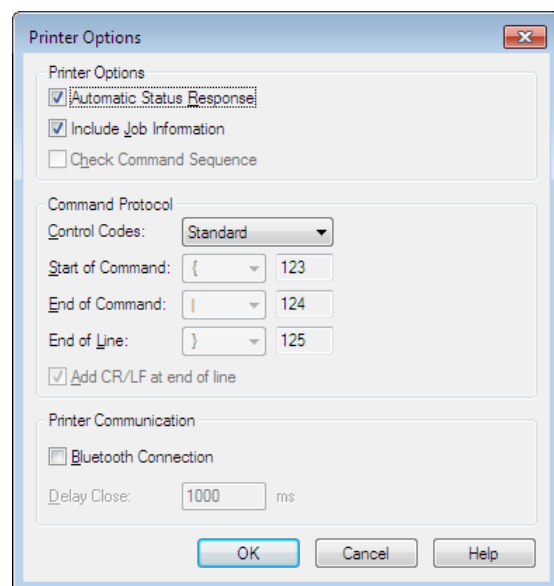

• Configure Memory

If the allocated memory sizes differ and when "Configure Memory" is clicked, the screen on the right is displayed to enable partitioning the internal memory or the expansion memory into areas of the specified size. When [OK] is clicked, the changed memory allocation will be set to the printer.

If the specified memory size is different from those of the printer, the printer automatically re-allocates in order of priority.

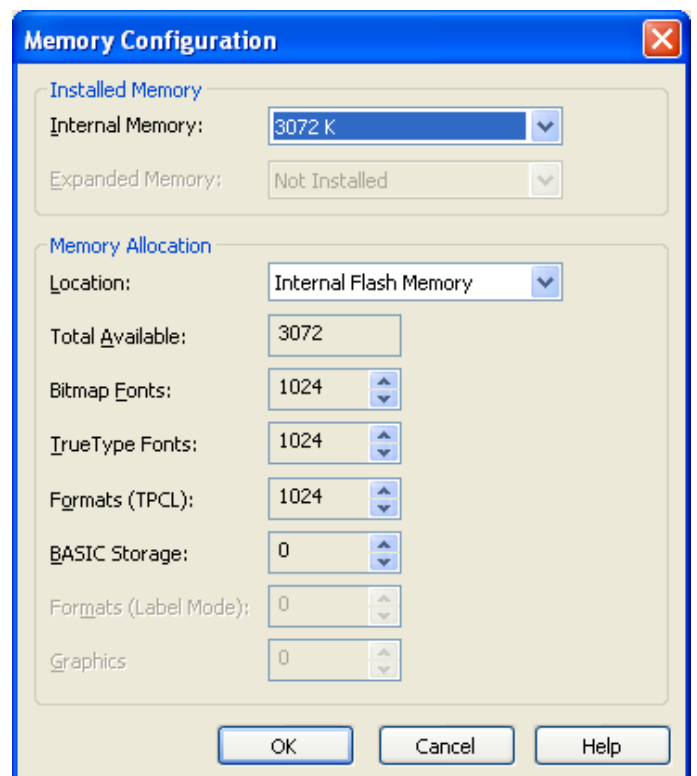

- **Erase Memory**

When “Erase Memory” is clicked, the screen on the right is displayed to enable formatting the specified flash memory. When [OK] is clicked, the memory format is executed.

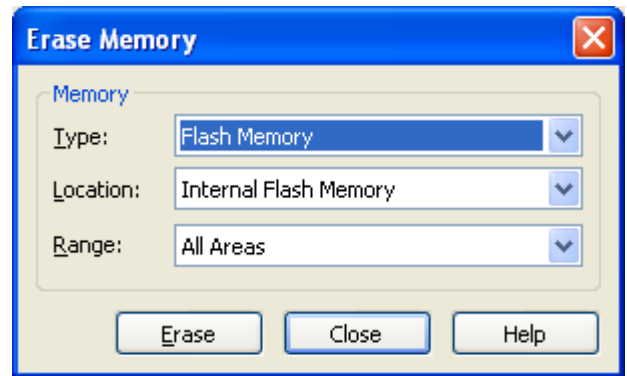

- **Ribbon Settings**

When “Ribbon Settings” is clicked, the screen on the right appears to enable fine adjustment of the ribbon motor voltages. Adjusting the ribbon motor voltage is effective to improve ribbon slack or wrinkles.

Before changing the default settings, refer to the manual of each printer model. When [OK] is clicked, the changes are sent to the printer.

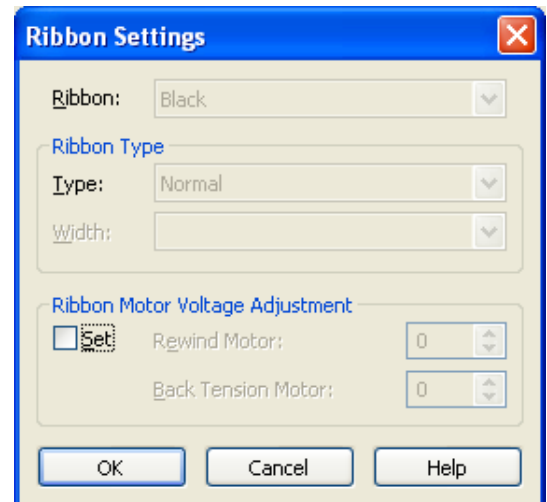

- **Driver**

- ◆ **Driver Options**

- **Administration tab**

Enables saving the settings of this printer driver in a file or importing the settings into a different or freshly installed printer driver. It also allows importing previously saved settings to replace the current settings of this printer driver.

Import: Allows reading the checked items from “Driver Setting File (*.sds)” to replace the current settings. The files of the older versions having a file extension of “sfm”, “sbf”, “spr” or “sdm” can be also used; however, a part of the items cannot be replaced.

Export: Allows saving the checked items in “Driver Setting File (*.sds).”

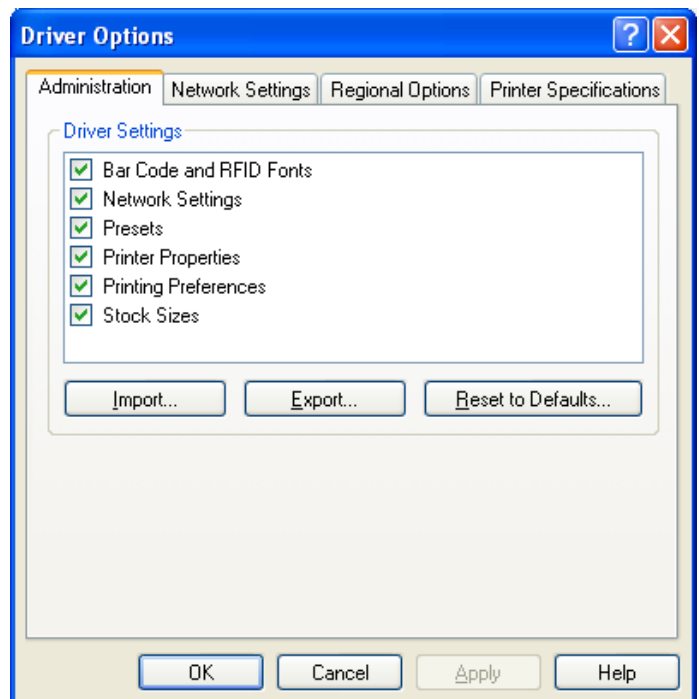

Reset to Defaults: Allows restoring the checked items to the factory default.

- Bar Code and RFID Fonts Registered barcode fonts
- Network Settings Setup information of the [Network Settings]
- Presets Registered preset lists
- Printer Properties Settings of stocks, graphics, print conditions, and various print configurations.
- Printing Preferences Settings configured in the Printer Options, Driver Options, Font Settings, etc.
- Stock Sizes Registered stock settings

• **Network Settings tab**

When the shared printer is installed as a network printer, its setup information or statuses can be shared between the server and the client.

This feature is not supported. To set the printer as a network printer, refer to **To print on the shared printer** and follow the procedure.

Note: Disable “Bidirectional support” on the client PC.

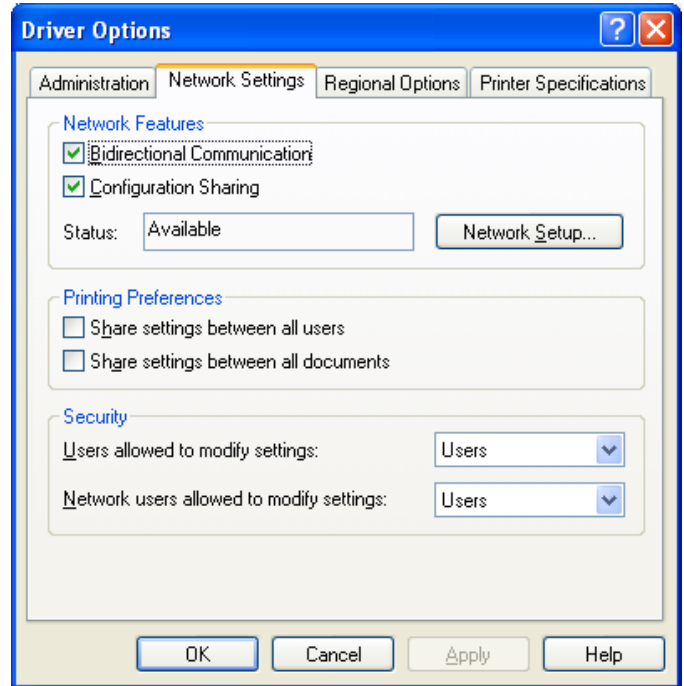

• **Regional Options tab**

Allows changing the language and units of measurement to agree with the region in which these printers are being used.

Language Selection: Allows selecting the desired language to be used.

Language

- Use Windows Setting
- English
- Dutch
- German
- Portuguese (Brazil)
- Chinese (Simplified)
- Czech
- Danish
- Finnish
- Greek
- Hungarian
- Korean
- Turkish
- Italian
- Spanish
- French
- Japanese
- Chinese (Traditional)
- Norwegian
- Polish
- Portuguese (Portugal)
- Russian
- Swedish
- Thai

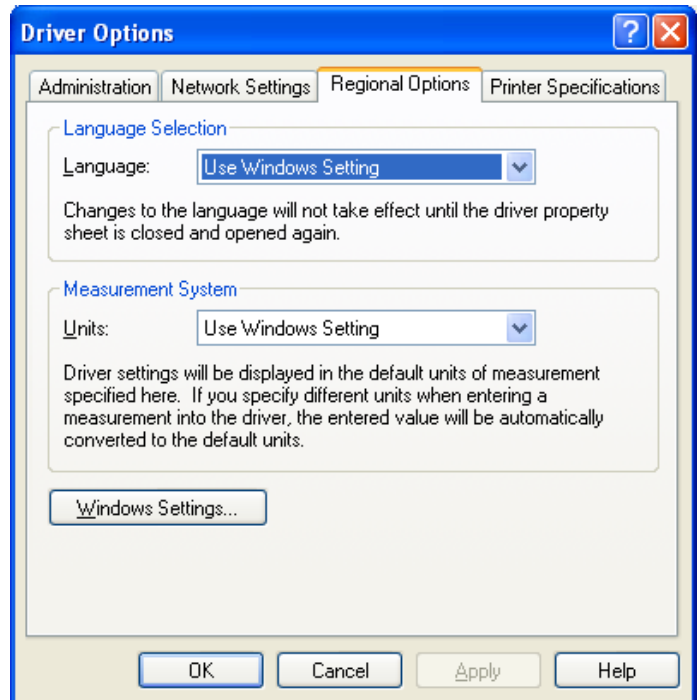

Measurement System: Allows selecting the desired unit of measure.

Units

- Use Windows Setting
- Inches
- Millimeters
- Centimeters

Windows Settings: Displays “Regional and Language Options” of Windows.

• **Printer Specifications tab**

Unprintable Width: Allows making minor adjustments in the horizontal positioning of the printed image on the label. Since this feature is not supported, do not change the default setting.

Model Specifications: Allows setting the specification of the printer, such as the resolution and media size. Since this feature is not supported, do not change the default settings. If they are changed, printing cannot be performed properly.

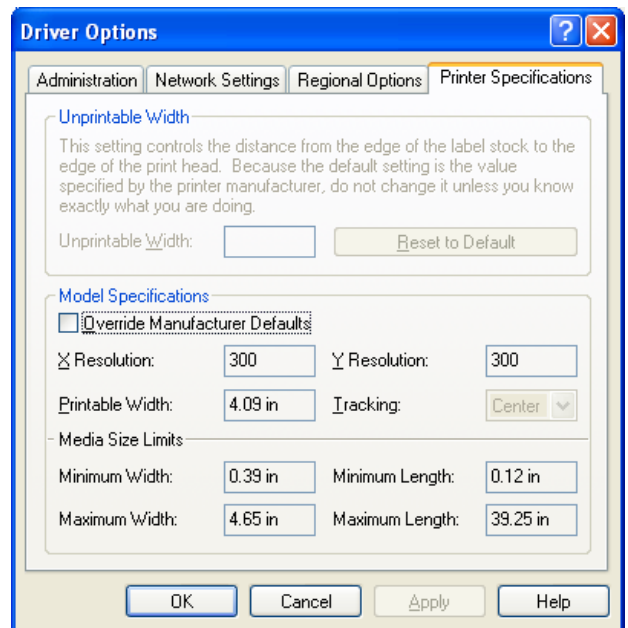

◆ Logging Options

Supports logging print jobs and recording printer code to files for debugging purposes. This feature is available only when the “Bidirectional support” is enabled.

• Logging tab

Enables recording printed pages and job history to a file or as event logs. Only the Legacy Log, created by clicking [Tools] and “Add Legacy Log”, is supported.

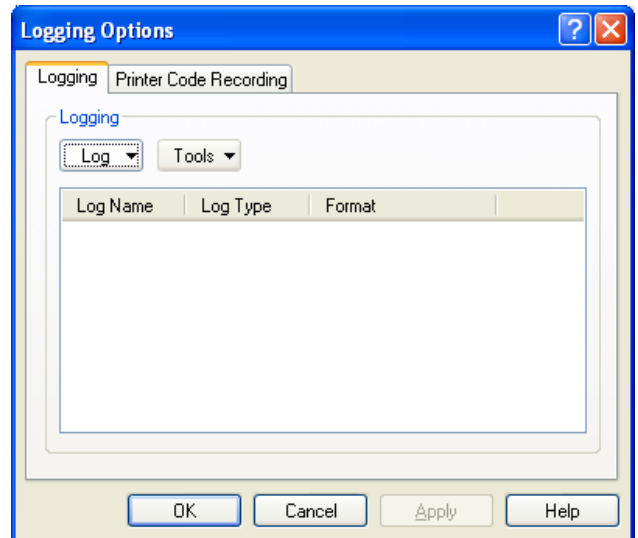

- * The Legacy Log is saved as a txt format or a csv format file. The maximum size complies with the specification of the file system specified for the format and output destination. If no space remains, the performance will comply with the specifications of the txt or csv file and the Windows OS, resulting in an error (insufficient space for writing).

• Printer Code Recording tab

Allows recording of all of the commands sent to the printer to a file. When the “Record Printer Code” check box is selected, the printer codes are recorded to the specified directory. Unlike using the “Print to File” option in most applications, “Printer Code Recording” allows printing to the printer and to a file simultaneously.

To reduce the load of the hard disk, the created files need to be deleted periodically.

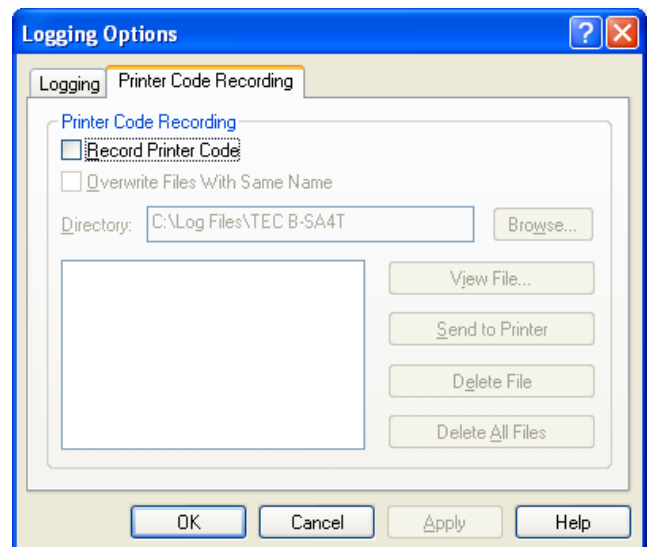

◆ Status Monitoring

• Status tab

Enables monitoring the printer status.

Applicable printer models:

B-SX4T (203 dpi), B-SX4T-CN (203 dpi), B-SX5T (305 dpi), B-SX5T-CN (305 dpi), B-SV4, B-SA4T (203 dpi), B-SA4T-CN (203 dpi), B-SA4T (300 dpi), B-SA4T-CN (300 dpi), B-852-R, B-452-R, B-462-R, B-EP2DL-G, B-EP4DL-G, B-SX6T (305 dpi), B-SX8T (305 dpi), B-EX4T1 (203 dpi), B-EX4T1 (305 dpi), B-EX4T2 (203 dpi), B-EX4T2 (300 dpi), B-EX4T2 (600 dpi), B-EX4D2 (203 dpi), B-FV4 (203 dpi), B-FV4 (300 dpi), B-FP3D (203 dpi), B-EX6T1 (203 dpi), B-EX6T1 (305 dpi), B-EX6T3 (203 dpi), B-EX6T3 (305 dpi), B-EX4T3 (600 dpi), DB-EA4D, BA410, BA420, B-FP2D, BV400-G and BV400-T

Requirements to use the status monitor:

- The printer and the PC are connected with a serial interface cable.
- The printer and the PC are connected with a parallel interface cable and “CENTRO. MODE” and “PLUG & PLAY” are set to “ECP” and “ON”, respectively. (B-SX4T/SX5T only)
- The printer and the PC are connected with a USB cable.
- The printer and the PC are connected with a LAN cable.

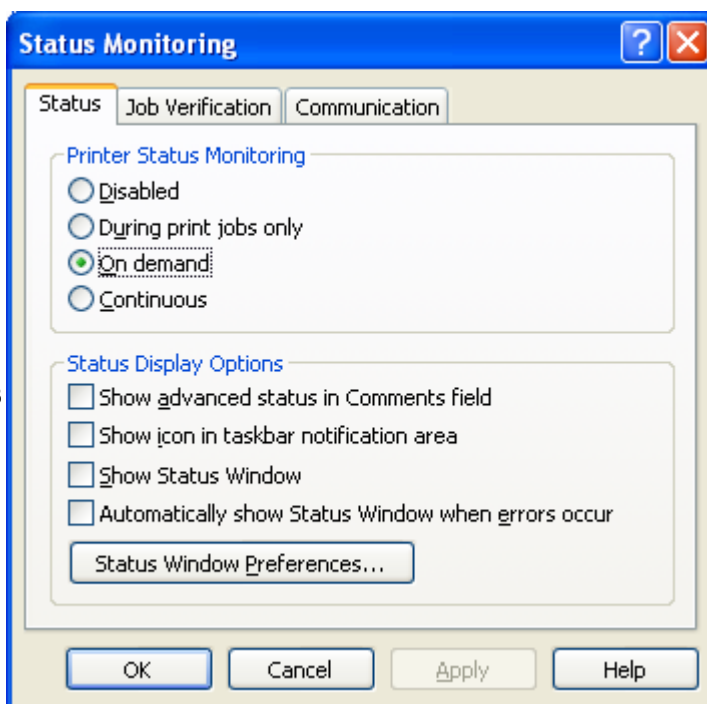

Printer Status Monitoring:

Enables selecting how to start the status monitor.

- Disabled: Printer status is not monitored.
- During print jobs only: Printer status is monitored while a print job exists in the print queue.
- On demand: Printer status is monitored only while printing.
- Continuous: Printer status is always monitored.

Status Display Options:

Show advanced status in Comments field: When checked, a printer status is displayed on the Comment column of the “Printer & FAX” window. Since this feature is not supported, do not change the default settings.

Show icon in taskbar notification area: When checked, the status monitor icon is displayed on the task bar and the printer statuses are periodically monitored.

Show Status Window: When checked, the status monitor’s status window is displayed. Remove the check or click [X] to close the window.

- Printer: Name of the printer monitored.
- Port: Output port monitored. The printer uses this port for printing.
- Status: Printer status This is equivalent to the message displayed on the printer LCD. This windows only shows the printer statuses, not detailed information like the number of unprinted labels.

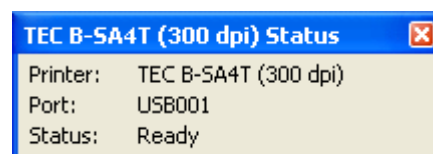

Ready	Paused	Printing
Ready, Ribbon Low	Paused, Ribbon Low	Printing, Ribbon Low
Ready, Paper near end	Pause, Paper near end	Printing, Paper near end
Command Error	Offline	Out of Paper
Out of Ribbon	Head Open	Paper Jam
Cutter Error	Ribbon Error	Sensor Error
Door Open	RFID Write Error	RFID Error
Label Present	I/O Error	Motor Temperature High
Head Temperature High	Ambient Temperature Error	Output Full
Battery Temperature High	Low Battery	Charge Error

Bluetooth Setting Error	Battery Warning	Head Temperature Warning
Motor Temperature Warning	Memory Write Error	Memory Error
Memory Card Error	Busy	RFID Setting Error

[How to recover from an error]

When an error like “NO PAPER” occurred on the printer, clear the cause of the error, and press the [RESTART] key on the printer.

For details, refer to the Owner’s Manual of each printer.

Automatically show Status Windows when errors occur:

When checked, the printer status is periodically monitored and if an error occurred during printing, the status window is displayed.

Status Window Preferences:

Always on top: When checked, the status window is always displayed on the top of all other windows.

Hide titlebar: When checked, the titlebar of the status window is hidden.

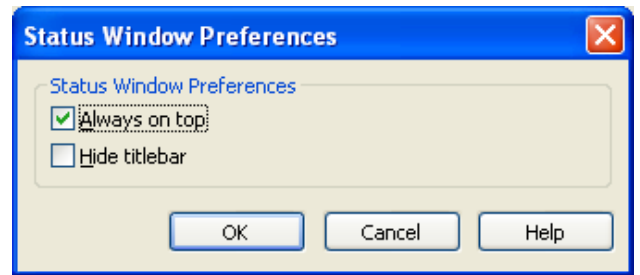

- **Job Verification tab**

Enables setting the print job monitoring method. When either checkbox is checked, printing is performed while verifying a completion of printing. Since this feature is not supported, do not change the default settings.

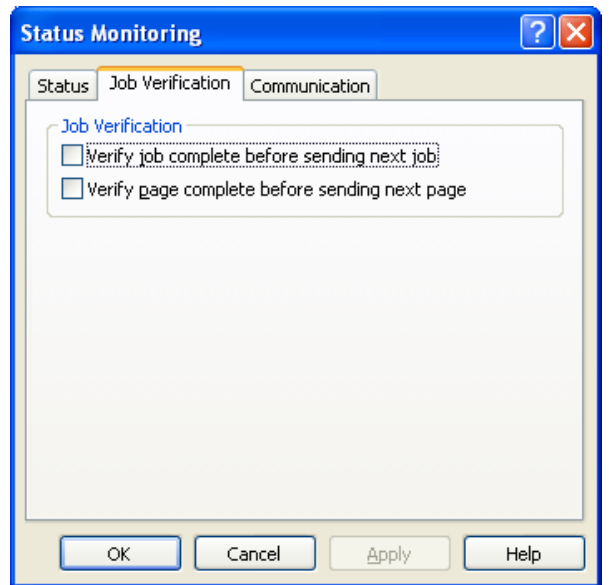

- **Communication tab**

Enables setting the timeout and polling interval for the status monitoring are set. Do not change the default settings.

Notes:

- Be sure to disable the status monitor when uninstalling the printer driver or changing the output port.
- When the printer is used as a shared printer, the status monitor window is not displayed on the client PC.
- While the status monitor is displayed, the ONLINE LED blinks periodically. This is not a failure.
- DO NOT enable the status monitor for the printers other than B-SX4T (203 dpi), B-SX4T-CN (203 dpi), B-SX5T (305 dpi), B-SX5T-CN (305 dpi), B-SV4, B-SA4T (203 dpi), B-SA4T-CN (203 dpi), B-SA4T (300 dpi), B-SA4T-CN (300 dpi), B-852-R, B-452-R, B-462-R, B-EP2DL-G, B-EP4DL-G, B-SX6T (305 dpi), B-SX8T (305 dpi), B-EX4T1 (203 dpi), B-EX4T1 (305 dpi), B-EX4T2 (203 dpi), B-EX4T2 (300 dpi), B-EX4T2 (600 dpi), B-EX4D2 (203 dpi), B-FV4 (203 dpi), B-FV4 (300 dpi), B-FP3D (203 dpi), B-EX6T1 (203 dpi), B-EX6T1 (305 dpi), B-EX6T3 (203 dpi), B-EX6T3 (305 dpi), B-EX4T3 (600 dpi), DB-EA4D, BA410, BA420, B-FP2D, BV400-G and BV400-T.
- It takes time to detect an OFFLINE status. (30 sec. at least)
- If the “Show icon in taskbar notification area” and “Show Status Window” check boxes are selected, the status monitor may not work properly when the PC is started. If “OFFLINE” is displayed at the start of the PC, remove the checks from these options.

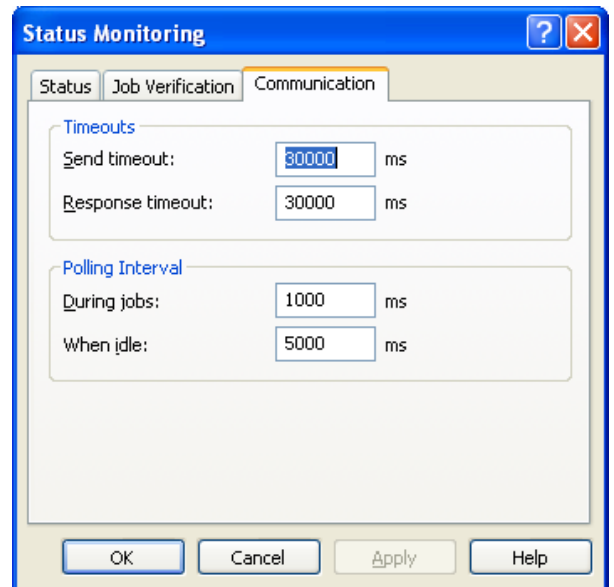

3.7 Designation of Printer Font

It is possible to use the printer's resident fonts and barcode symbologies within any Windows application by selecting the printer fonts like "TEC Kanji" for the data to be converted.

■ Example of selecting a font on the application

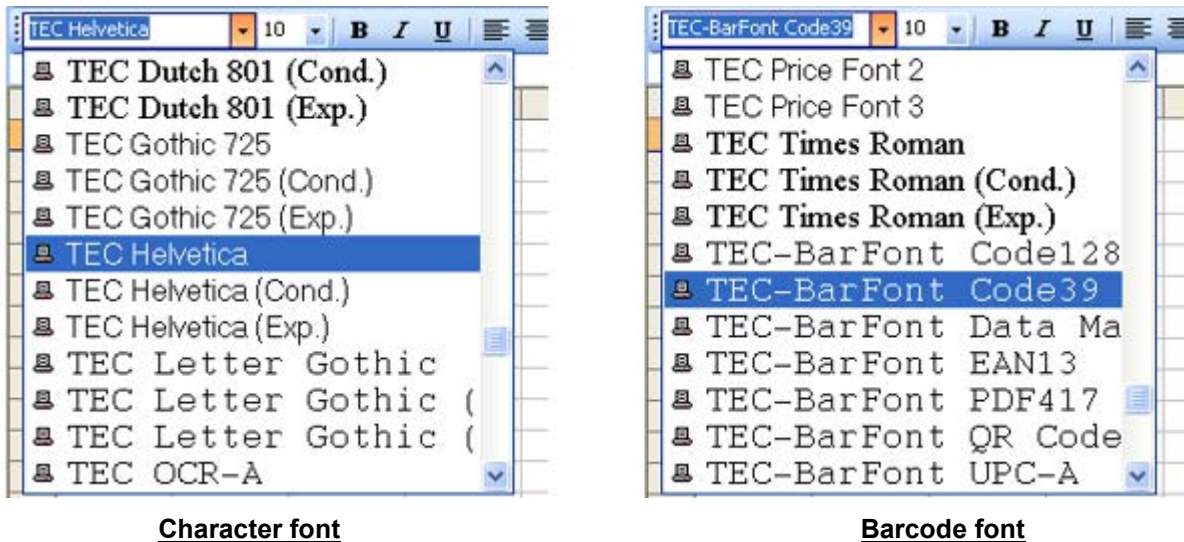

Supplement:

- The name of the printer fonts (barcode or 2D code fonts) for the Toshiba TEC barcode printers starts with "TEC", like "TEC Kanji". Although the "TEC ***" fonts do not appear as barcodes on the screen, they will be converted by the driver into the desired barcodes.
- It is possible to expect an increase of the printing throughput if the printer font is used.
- Printer fonts (including barcode fonts) shown on the application screen look different from the actually printed ones in on appearance and size.
- To use the TEC Kanji Outline fonts on B-372, B-472 and B-872, separately sold fonts are required.

■ Example of barcode font programming (Visual Basic 5.0/6.0)

In the case the registered barcode font name is "BarFont Code 39":

```
Private Sub Command1_Click()  
Printer.FontName = "TEC-BarFont Code39"  
Printer.FontSize = 36  
Printer.FontBold = False  
Printer.FontItalic = False  
Printer.CurrentX = 1000  
Printer.CurrentY = 1000  
Printer.Print "1234567"  
Printer.EndDoc  
End Sub
```

Note: The Visual Studio.NET (VB/C#) or later does not support the above processing.

■ Restrictions of Bar Code Fonts

- Depending on the applications, barcode fonts may not be listed in the font types. Make sure that the application used supports the printer fonts.
- Barcode fonts do not appear as barcodes on the document of the application. Instead, characters or symbols are displayed.
- If a barcode rotation is specified, the actual print position differs from the position specified by the application. Print the data and adjust the position of the printed image.
- The height of barcode is specified by the character size point. The character size points are converted into millimeters on the basis of the following table, or there may be a case that the barcode font is converted into other character font and no barcode is printed.

Point	Bar height (mm)	Point	Bar height (mm)
8	2.8	36	12.7
9	3.2	48	16.9
10	3.5	60	21.2
11	3.9	72	25.4
12	4.2	108	38.1
14	4.9	144	50.8
18	6.4	180	63.5
24	8.5	216	76.2
30	10.6		

- In the case Kanji code is included in data, select the [Tool] tab, [Configure], "Printer options" and set "Control Codes" to "ESC/LF/NUL".

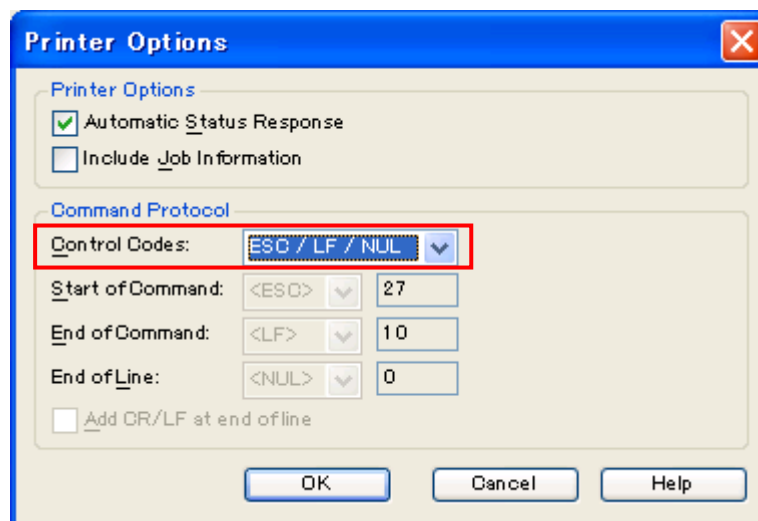

- When a control code or special code is used with the barcode font specified, refer to the following table and enter the corresponding data.
In the case a caret “^” is used, enter “^^” because the caret “^” is the default function character. If the function character is changed from “^” to the other in [User Commands] of [Advanced Options], replace the “^” with the specified character.

Control code	Input data	Control code	Input data	Special code	Input data
>@ (00H)	N/A	>P (10H)	^<DLE>	>0	>
>A (01H)	^<SOH>	>Q (11H)	^<DC1>		
>B (02H)	^<STX>	>R (12H)	^<DC2>		
>C (03H)	^<ETX>	>S (13H)	^<DC3>		
>D (04H)	^<EOT>	>T (14H)	^<DC4>		
>E (05H)	^<ENQ>	>U (15H)	^<NAK>		
>F (06H)	^<ACK>	>V (16H)	^<SYN>		
>G (07H)	^<BEL>	>W (17H)	^<ETB>		
>H (08H)	^<BS>	>X (18H)	^<CAN>		
>I (09H)	^<HT>	>Y (19H)	^		
>J (0AH)	^<LF>	>Z (1AH)	^<SUB>		
>K (0BH)	^<VT>	>[(1BH)	^<ESC>		
>L (0CH)	^<FF>	>\ (1CH)	^<FS>		
>M (0DH)	^<CR>	>] (1DH)	^<GS>		
>N (0EH)	^<SO>	>^ (1EH)	^<RS>		
>O (0FH)	^<SI>	>_ (1FH)	^<US>		

- When a special code is used with the barcode font(Code 128) specified, refer to the following table and enter the corresponding data.

Special code	Input data
>0	>
>1	^
>2	^3
>3	^2
>4	^s or ^S
>5	^c or ^C
>6	^b or ^B
>7	^a or ^A
>8	^1

- When a FNC1 is used as data delimiter of GS1 DataMatrix, specified the “^1”.

■ Correspondence table of the specified size of TEC Kanji and actually printed size

Unit: Point

305dpi		300dpi	
Specified size	Print size	Specified size	Print size
1.0 to 2.0	1.9	1.0 to 2.5	1.9
2.5 to 3.0	2.8	3.0 to 3.0	2.9
3.5 to 5.0	3.8	3.5 to 5.0	3.8
5.5 to 7.0	5.6	5.5 to 7.0	5.8
7.5 to 9.0	7.5	7.5 to 9.0	7.7
9.5 to 10.0	9.4	9.5 to 10.5	9.6
10.5 to 14.0	11.3	11.0 to 14.5	11.5
14.5 to 16.0	15.1	15.0 to 16.5	15.4
16.5 to 18.0	16.9	17.0 to 18.5	17.3
18.5 to 21.5	18.8	19.0 to 22.0	19.2
22.0 to 27.0	22.6	22.5 to 27.5	23.0
27.5 to 32.5	28.2	28.0 to 33.0	28.8
33.0 to 50.0	33.9	33.5 to 50.0	34.6

203dpi		600dpi	
Specified size	Print size	Specified size	Print size
1.0 to 3.5	2.8	1.0 to 1.0	1.0
4.0 to 5.0	4.3	1.5 to 1.5	1.4
5.5 to 7.5	5.7	2.0 to 2.5	1.9
8.0 to 10.0	8.5	3.0 to 3.5	2.9
10.5 to 13.5	11.3	4.0 to 4.5	3.8
14.0 to 15.5	14.2	5.0 to 5.0	4.8
16.0 to 21.0	17.0	5.5 to 7.0	5.8
21.5 to 27.0	22.7	7.5 to 8.0	7.7
27.5 to 32.5	28.4	8.5 to 9.0	8.6
33.0 to 57.5	34.0	11.5 to 13.5	11.5
		14.0 to 16.5	14.4
		17.0 to 25.0	17.3

4. System Configuration

The system requirements for this printer driver are as follows:

Computer	IBM PC-AT compatible
Windows	Microsoft Windows 10, Windows 11, Windows Server 2012, Windows Server 2016, Windows Server 2019
Printer	Toshiba Tec Barcode Printer
Centronics	Centronics interface cable
Printer server	Connection method to Ethernet <u>B-SV4</u> : Optional LAN adapter <u>B-SX</u> : Optional PCMCIA board and LAN card <u>B-SX</u> : Optional LAN board <u>B-SA4/B-852-R/B-452-R/B-EP2/B-EP4/B-EV4/B-SX6T/8T/B-EX4T1/T2/B-462-R/B-FP/B-EX6T1/B-EX6T3/B-EX4T3/DB-EA4D/BA400/B-FP2D-G/BV400</u> The LAN interface is provided as standard.

Notes:

1. When the printer server is used, set the port by following the guideline of the printer server device.
2. When the Toshiba TEC optional LAN board or a set of the optional PCMCIA board and a LAN card is used to connect the printer to the LAN, refer to **Section 6.3 How to Connect the Printer to LAN**.
3. When the printer is used as the network printer, refer to **To print on the shared printer** described in the installation procedure by an OS.

4.1 System Configuration Example

■ Example 1 In the case a Windows PC is directly connected to the printer.

Install the printer driver (for Windows 9X or Windows NT) in the PC #1.
Specify the LPT1 (local port) for the output port.

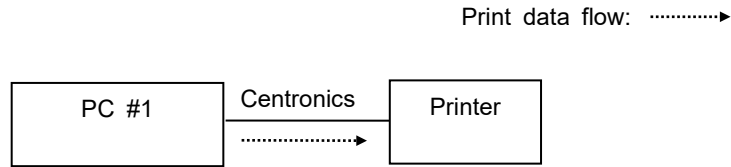

■ Example 2 In the case the printer is directly connected to the Windows PC #1 and printing is initiated from another Windows PC #2 via TCP/IP

1. Install the printer driver (for Windows 9X or Windows NT) in the PC #1.
Specify the LPT1 (local port) for the output port.
2. Right-click the printer icon, open the Properties, and specify the printer connected to the PC #1 as a shared printer.
3. Install the printer driver (for Windows 9X or Windows NT) in the PC #2.
4. Specify the network path of the printer connected to the PC # 1 and install it as a network printer.

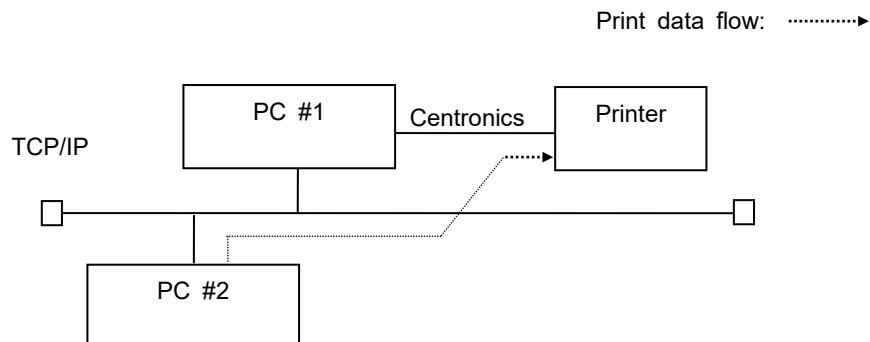

■ **Example 3** In the case print jobs are sent from Windows PC #2 (Windows 9x) and Windows PC #3 (Windows NT) to the Windows PC #1 (Windows NT) via TCP/IP, and these print jobs are sent from the PC #1 to multiple printers

1. Install the printer drivers (for Windows NT) in the PC #1 for the number of printers connected.
2. Right-click the printer icon on the PC #1, open the Properties and add the LPR port specifying the printer server address.
3. In the Properties screen, specify the printer on the network as the shared printers.
4. Install the printer driver (for Windows 9X) in the PC #2.
5. Specify the network path of the printer connected to the PC # 1 and install it as a network printer.
6. Install the printer driver (for Windows NT) in the PC #3.
7. Specify the network path of the printer connected to the PC #1 and install it as a network printer.

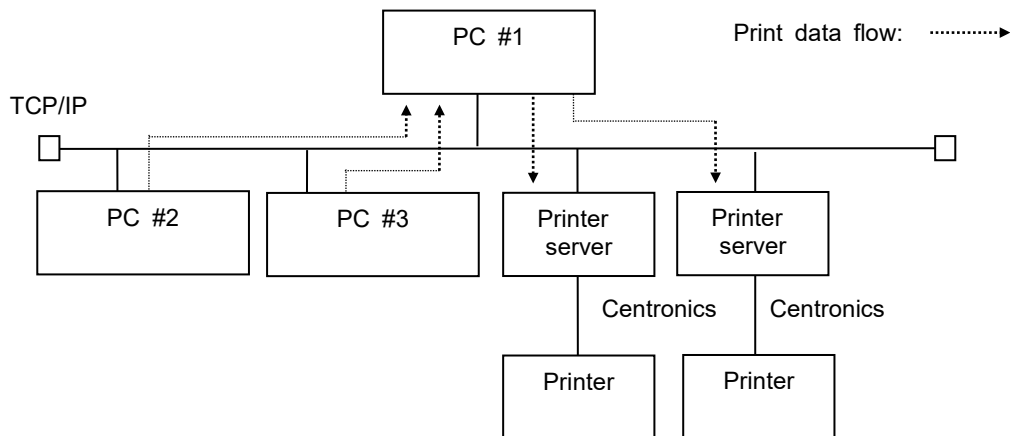

■ **Example 4** In the case print jobs are sent from Windows PC #1 (Windows 9x) and Windows PC #2 (Windows NT) to the multiple printers via TCP/IP

1. Install the printer drivers (for Windows 9X) in the PC #1 for the number of printers connected.
2. Add the LPR port specifying the printer server address. (Use other software like the printer server specific setting utility to add the LPR port.)
3. Specify the LPR Port added in Step 2 above as the print port of the PC #1.
4. Install the printer drivers (for Windows NT) in the PC #2 for the number of printers connected.
5. Right-click the printer icon on the PC #2, open the Properties, and add the LPR port specifying the printer server address.
6. Specify the LPR Port added in Step 5 above as the print port of the PC #2.

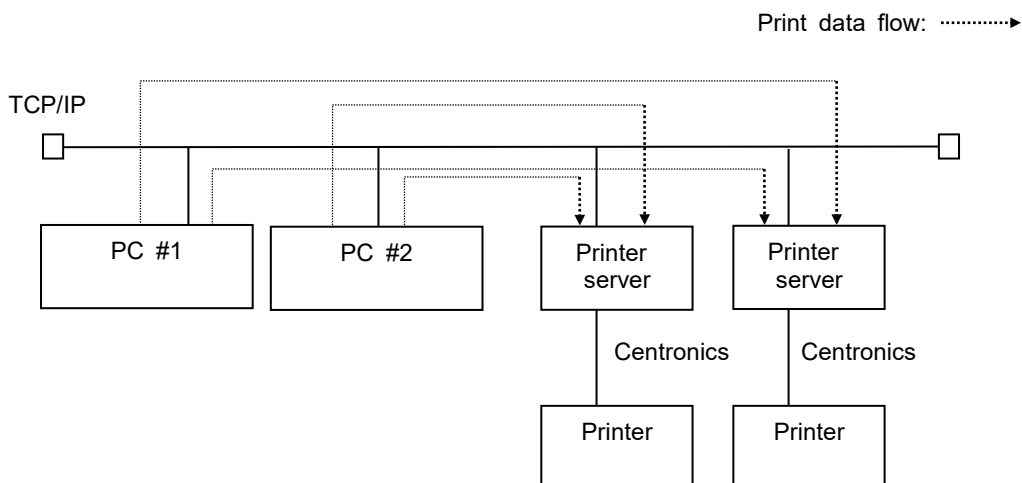

5. Addition and Deletion of Standard TCP/IP Port

When connecting the printer via LAN interface, configure the following settings on the printer using the printer system mode menu <7>IP ADDRESS.

- PRINTER IP ADDRESS
- GATEWAY IP ADDRESS
- SUBNET MASK
- SOCKET PORT

The above PRINTER IP ADDRESS and SOCKET PORT are used as the “Printer Name or IP address” and “Port No.”, respectively when adding a port.

Note: When “Bidirectional support” is used, do not specify the same output port for the multiple printer drivers on a computer. When you want to specify the same output port for the multiple printer drivers, disable [Printer Status Monitoring]. Also, when multiple computers connect to the same printer, specify that printer as the shared printer or disable [Printer Status Monitoring].

5.1 Addition

1. Right-click the printer icon and click “Properties” to open the printer properties screen.

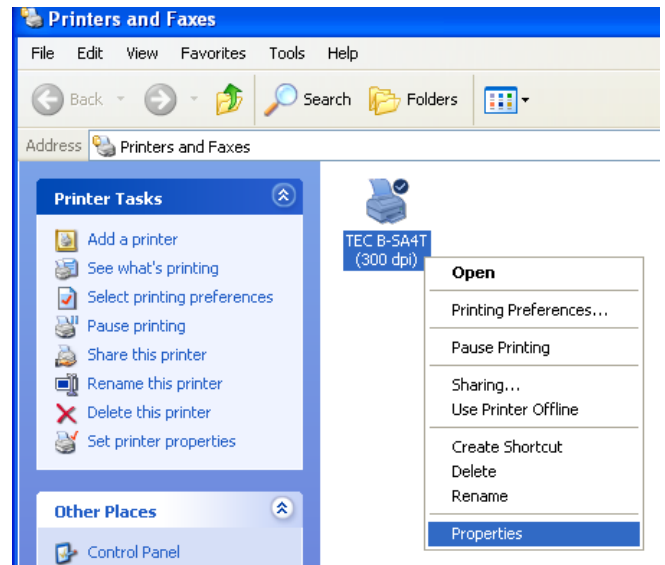

2. Select the [Ports] tab and click [Add Port].

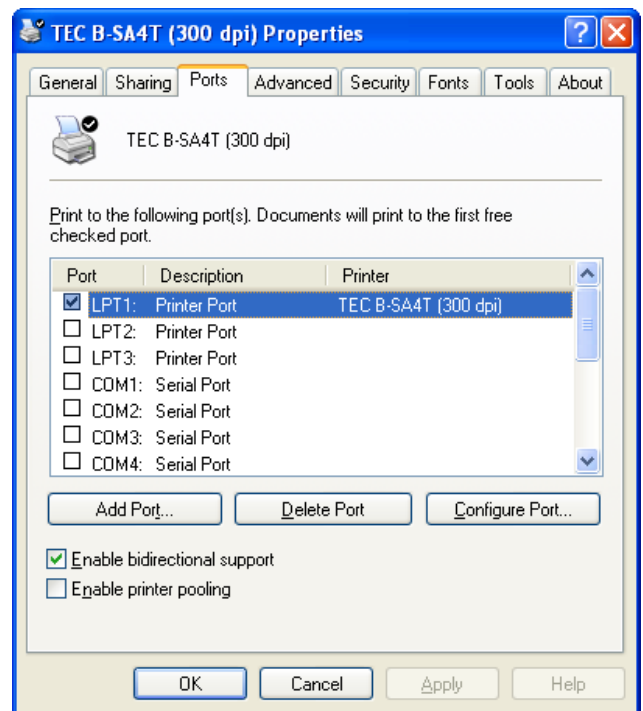

3. Select “Standard TCP/IP Port” from the “Available port types” list, then click [New Port].

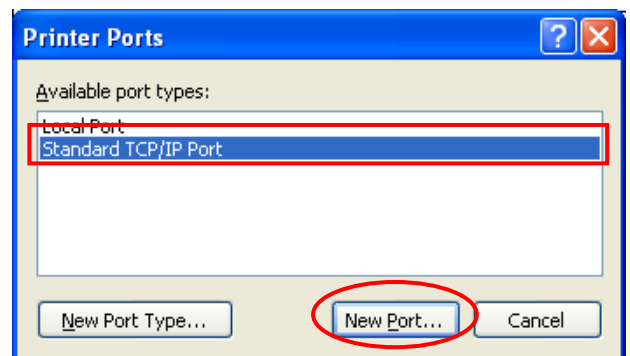

4. After “Add Standard TCP/IP Printer Port Wizard” is started, click [Next].

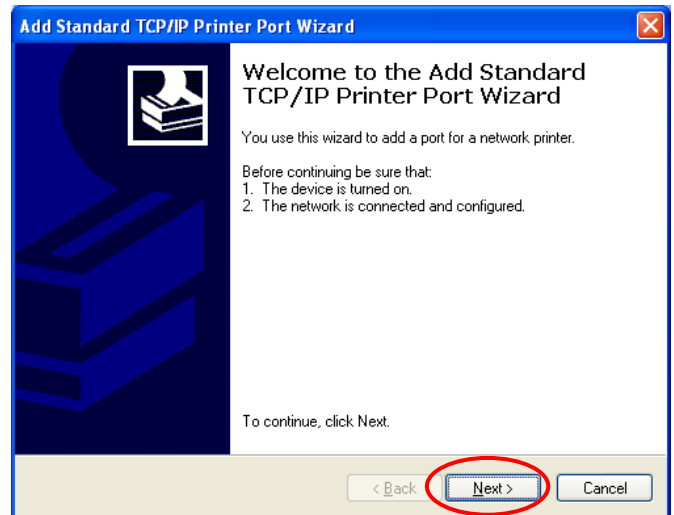

5. Type in “Printer Name or IP Address” and click [Next].

Note: The Port Name is automatically set when the “Printer Name or IP Address” is entered.

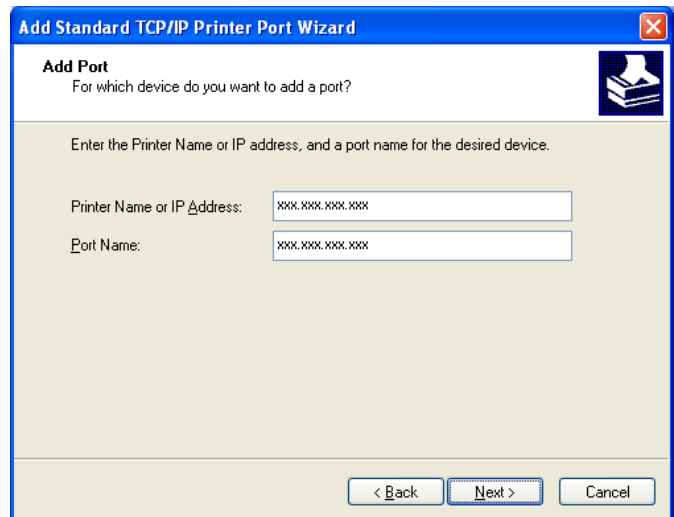

6. Select “Device Type” to “Custom”, then click [Settings].

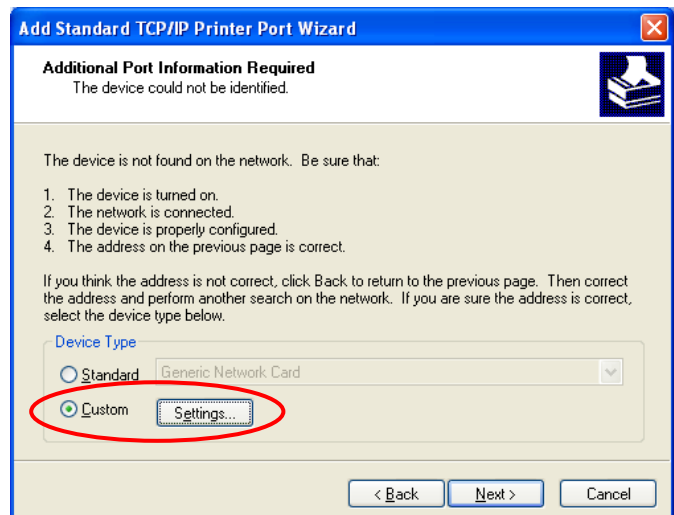

7. When you choose “Raw” for the Protocol, enter the printer SOCKET PORT as “Port Number” and click [OK]. Do not select the “SNMP Status Enabled” check box.

When you choose “LPR” for the Protocol, enter any queue name (e.g.: “lpr”) and click [OK]. Do not select the “LPR Byte Counting Enabled” and “SNMP Status Enabled” check boxes.

Note: When the status monitor feature is used with the bidirectional support, select “Raw”.

[Default port number]
The default port number is “9100”. But there is in case of “8000”.

Configure Standard TCP/IP Port Monitor

Port Settings

Port Name: xxx.xxx.xxx.xxx

Printer Name or IP Address: xxx.xxx.xxx.xxx

Protocol

Raw LPR

Raw Settings

Port Number: 8000

LPR Settings

Queue Name:

LPR Byte Counting Enabled

SNMP Status Enabled

Community Name: public

SNMP Device Index: 1

OK Cancel

8. Click [Next] and [Finish].

Add Standard TCP/IP Printer Port Wizard

Completing the Add Standard TCP/IP Printer Port Wizard

You have selected a port with the following characteristics.

SNMP: No

Protocol: RAW, Port 8000

Device: xxx.xxx.xxx.xxx

Port Name: xxx.xxx.xxx.xxx

Adapter Type:

To complete this wizard, click Finish.

< Back Finish Cancel

9. When “Add Standard TCP/IP Printer Port Wizard” is finished, a new port is added.

5.2 Deletion

1. Right-click the printer icon and click "Properties" to open the printer properties screen.

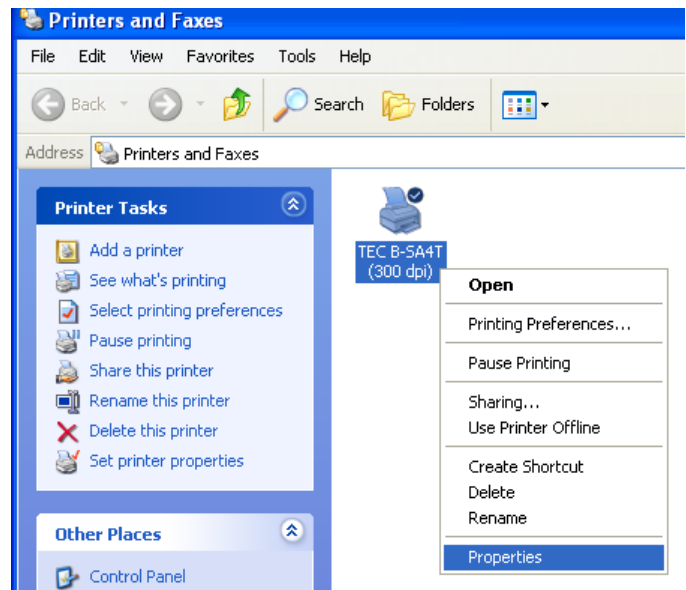

2. Select the [Ports] tab and click [Delete Port].

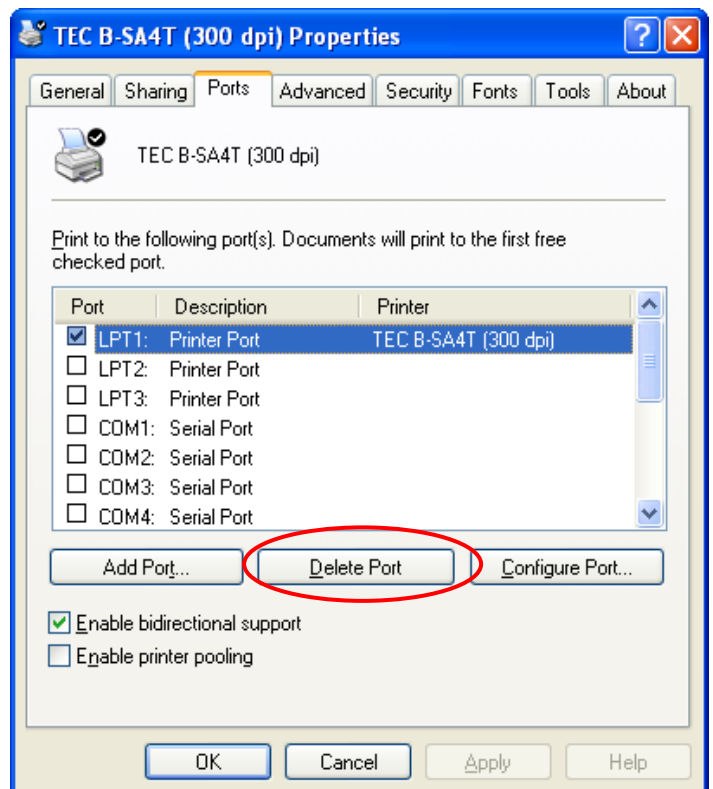

3. When the deletion of the port is completed, it is deleted from the print port.

6. Appendix

6.1 How to Enable Bidirectional Communication Support

1. Right-click the printer icon and open the Properties.

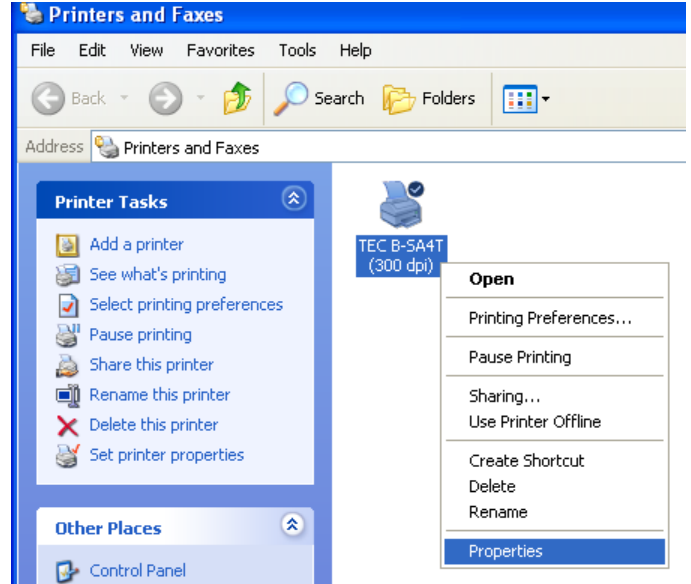

2. Click the [Port] tab.

To enable the bidirectional support, select the "Enable bidirectional support" check box.

To disable the bidirectional support, remove the select from the "Enable bidirectional support" check box.

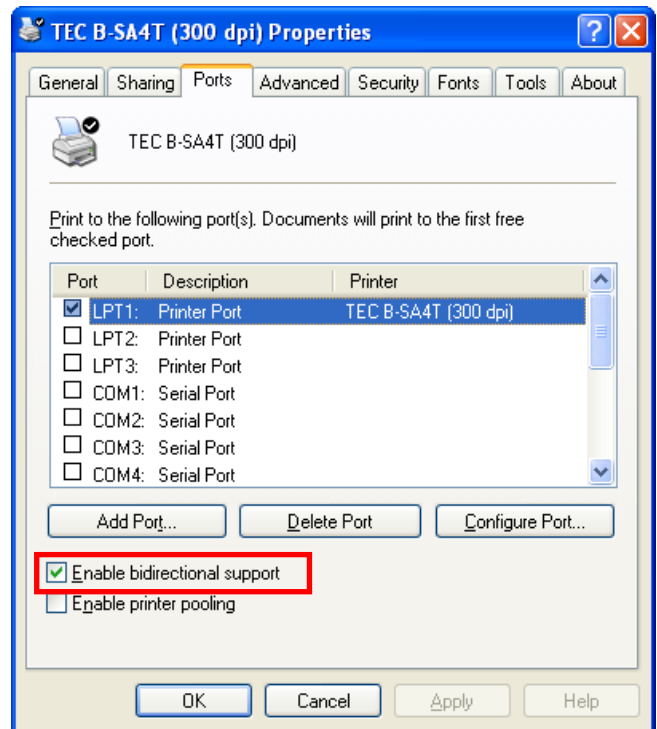

6.2 Parameter Setting on the Printer

For how to set the parameters, refer to the Owner's Manual supplied with the connected TOSHIBA barcode printer.

Note: The following example is the parameter setting procedure for B-SX5T.
 "CENTRO. MODE" is set to "ECP" and "PLUG & PLAY" is set to "ON", respectively.

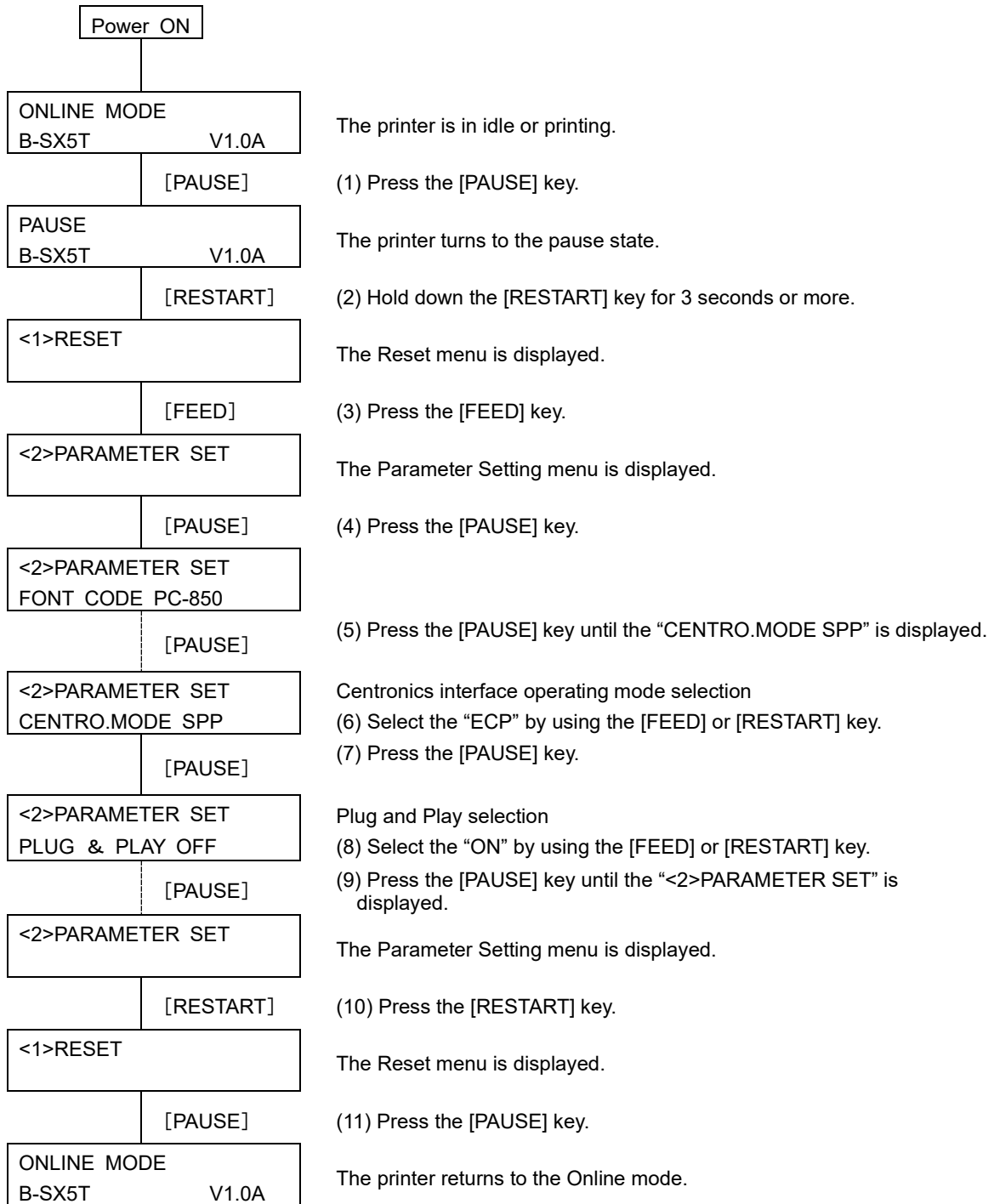

6.3 How to Connect the Printer to LAN

Right-click the printer icon, open the Properties, add a printer port and specify it as an output port.

The output port to be used differs depending on the printer models and communication methods (unidirectional/bidirectional).

■ Printer Port Types

LAN interface	Printer model	Method	Printer board Standard TCP/IP Port
Optional LAN board			
B-SV704-LAN-QQ/QP-R	B-SV4D (Except GS12) B-SV4T	Unidirectional	Raw or LPR protocol
B-9700-PCM-QM-R	B-SX4T (203 dpi) B-SX5T (305 dpi)	Unidirectional	Raw or LPR protocol
B-9700-LAN-QM-R		Bidirectional	Raw protocol
Standard feature			
	B-EV4 (203 dpi) B-EV4 (300 dpi)	Unidirectional	LPR protocol
	B-SA4T (203 dpi) / B-SA4T-CN (203 dpi) B-SA4T (300 dpi) / B-SA4T-CN (300 dpi)	Unidirectional	Raw or LPR protocol
	B-852-R B-452-R B-462-R B-EP2DL-G B-EP4DL-G B-SV4D-GS12-QM-R B-SX6T (305 dpi) B-SX8T (305 dpi) B-EX4T1 (203 dpi) B-EX4T1 (305 dpi) B-EX4T2 (203 dpi) B-EX4T2 (305 dpi) B-EX4T2 (600 dpi) B-EX4D2 (203 dpi) B-EX6T1 (203 dpi) B-EX6T1 (305 dpi) B-EX6T3 (203 dpi) B-EX6T3 (305 dpi) B-EX4T3 (600 dpi) B-FV4 (203 dpi) B-FV4 (300 dpi) BA410T(203 dpi) BA420T(203 dpi) BA410T(300 dpi) BA420T(300 dpi) B-FP3D (203 dpi) B-FP2D (203 dpi) BV400 (203 dpi) BV400 (300 dpi) DB-EA4D	Bidirectional	Raw protocol

Note: In the case of the unidirectional communication, be sure to disable the [Printer Status Monitoring].

Toshiba Tec Corporation

1-11-1, Osaki, Shinagawa-ku, Tokyo 141-8562

Gate City Ohsaki West Tower

Copyright ©2022-2023 Toshiba Tec Corporation All rights reserved

BS220050A0-EN